



FİYAT LİSTESİ

2021/1

*Fiyatlarımızdaki baskı ve dizgi aşamasında ortaya çıkabilecek sorunlarda "MERTİNOKS A.Ş." sorumlu değildir.
"MERTİNOKS A.Ş." fiyatlarda ve görsellerde her türlü değişiklik yapma hakkına sahiptir.*

İNDEX

ÇÖP KOVALARI

04

WC FIRÇALIKLAR

20

ENGELLİ SERİSİ

23

DUŞ SETLERİ

31

DUŞ KANALLARI

44

YER SİFONLARI

78

DRENAJ KANALLARI

100

AKSESUARLAR

114

INOX BORDÜRLER

139

İKON AÇIKLAMALARI



Yan Çıkış



Alt Çıkış



İç Mekan



Dış Mekan



Sıcak - Soğuk Çalışma Ortamı



Banyo (Islak Hacim)



File Montajlı



Tekstil Membran Montajlı



Bitüm Membran Montajlı



Düşük Yoğunluk Su Akışı



Yüksek Yoğunluk Su Akışı



Kilitli Sistem

PEDALLI ÇÖP KOVALARI

STANDART

Ürün Kodu	Kısa Kod	Çap	Yükseklik	Kalite	Fiyat
-----------	----------	-----	-----------	--------	-------

SS 430

4501.1825S.430.03	13231	3 L	Ø 21	22 cm	S.S. 430	8	81.70
4501.2028S.430.05	13234	5 L	Ø 21	26 cm	S.S. 430	8	96.70
4501.2035S.430.08	13235	8 L	Ø 21	35 cm	S.S. 430	6	116.70
4501.2435S.430.12	13236	12 L	Ø 25	35 cm	S.S. 430	6	141.70
4501.2444S.430.16	13237	16 L	Ø 25	44 cm	S.S. 430	4	190.00
4501.3135S.430.20	13238	20 L	Ø 31	36 cm	S.S. 430	4	248.40
4501.3144S.430.30	13239	30 L	Ø 31	45 cm	S.S. 430	4	273.40
4501.3163S.430.40	13240	40 L	Ø 31	63 cm	S.S. 430	4	356.70

SS 304

4501.1825S.304.03	13241	3 L	Ø 21	22 cm	S.S. 304	8	110.00
4501.2028S.304.05	13242	5 L	Ø 21	26 cm	S.S. 304	8	126.70
4501.2035S.304.08	13243	8 L	Ø 21	35 cm	S.S. 304	6	156.70
4501.2435S.304.12	13248	12 L	Ø 25	35 cm	S.S. 304	6	190.00



- Paslanmaz gövde
- Pedalli



AMORTİSÖRLÜ KAPAK

Ürün Kodu	Kısa Kod	Çap	Yükseklik	Kalite	Fiyat
-----------	----------	-----	-----------	--------	-------

SS 430

4501.1825Y.430.03	13249	3 L	Ø 21	22 cm	S.S. 430	8	103.40
4501.2028Y.430.05	13250	5 L	Ø 21	26 cm	S.S. 430	8	118.40
4501.2035Y.430.08	13254	8 L	Ø 21	35 cm	S.S. 430	6	138.40
4501.2435Y.430.12	13255	12 L	Ø 25	35 cm	S.S. 430	6	163.40
4501.2444Y.430.16	13268	16 L	Ø 25	44 cm	S.S. 430	4	201.70
4501.3135Y.430.20	21355	20 L	Ø 31	36 cm	S.S. 430	4	276.70
4501.3144Y.430.30	21356	30 L	Ø 31	45 cm	S.S. 430	4	313.40
4501.3163Y.430.40	21357	40 L	Ø 31	63 cm	S.S. 430	4	390.00

SS 304

4501.1825Y.304.03	13256	3 L	Ø 21	22 cm	S.S. 304	8	128.40
4501.2028Y.304.05	13260	5 L	Ø 21	26 cm	S.S. 304	8	143.40
4501.2035Y.304.08	13261	8 L	Ø 21	35 cm	S.S. 304	6	170.00
4501.2435Y.304.12	13262	12 L	Ø 25	35 cm	S.S. 304	6	195.00



- Paslanmaz gövde
- Pedalli



MICRO

Ürün Kodu	Kısa Kod	Çap	Yükseklik	Kalite	Fiyat
-----------	----------	-----	-----------	--------	-------

SS 430

4501.1725M.430.03	13210	3 L	Ø 17	24 cm	S.S. 430	8	75.00
4501.1825M.430.05	13212	5 L	Ø 21	22 cm	S.S. 430	8	83.40



PRATİK KAPAK

Ürün Kodu Kısa Kod Çap Yükseklik Kalite Fiyat

SS 430

4513.0000S.430.05	13269	5 L	Ø 21	26 cm	S.S. 430	8	165.40
4513.0000S.430.08	13271	8 L	Ø 21	32 cm	S.S. 430	8	177.40
4513.0000S.430.12	13272	12 L	Ø 25	32 cm	S.S. 430	6	215.70
4513.0000S.430.16	13274	16 L	Ø 25	38,5 cm	S.S. 430	6	230.00
4513.0000S.430.20	13275	20 L	Ø 25	46,5 cm	S.S. 430	6	257.70
4513.0000S.430.27	13276	27 L	Ø 25	57 cm	S.S. 430	6	280.00
4513.0000S.430.32	13277	32 L	Ø 31	46 cm	S.S. 430	4	324.40
4513.0000S.430.45	13278	45 L	Ø 31	57 cm	S.S. 430	4	353.40



• Paslanmaz gövde



YENİ!

RENKLİ

4513.0000B.101.08	28655	8 L	Ø 21	32 cm	BEYAZ	8	225.00
4513.0000S.102.08	28656	8 L	Ø 21	32 cm	SIYAH	8	225.00
4513.0000B.101.27	28660	27 L	Ø 25	57 cm	BEYAZ	6	376.00
4513.0000S.102.27	28661	27 L	Ø 25	57 cm	SIYAH	6	376.00
4513.0000B.101.45	28665	45 L	Ø 31	57 cm	BEYAZ	4	486.70
4513.0000S.102.45	28666	45 L	Ø 31	57 cm	SIYAH	4	486.70

• Paslanmaz gövde



PRATİK ÇEMBERLİ

Ürün Kodu Kısa Kod Çap Yükseklik Kalite Fiyat

SS 430

4514.0000S.430.05	13279	5 L	Ø 21	26 cm	S.S. 430	8	146.00
4514.0000S.430.08	13280	8 L	Ø 21	32 cm	S.S. 430	8	159.40
4514.0000S.430.12	13281	12 L	Ø 25	32 cm	S.S. 430	6	193.40
4514.0000S.430.16	13282	16 L	Ø 25	38,5 cm	S.S. 430	6	206.00
4514.0000S.430.20	13283	20 L	Ø 25	46,5 cm	S.S. 430	6	238.70
4514.0000S.430.27	13284	27 L	Ø 25	57 cm	S.S. 430	6	259.40
4514.0000S.430.32	13285	32 L	Ø 31	46 cm	S.S. 430	4	301.00
4514.0000S.430.45	13286	45 L	Ø 31	57 cm	S.S. 430	4	336.70



• Paslanmaz gövde



YENİ!

RENKLİ

4514.0000B.101.08	28670	8 L	Ø 21	32 cm	BEYAZ	8	180.00
4514.0000S.102.08	28671	8 L	Ø 21	32 cm	SIYAH	8	180.00
4514.0000B.101.27	28675	27 L	Ø 25	57 cm	BEYAZ	6	313.40
4514.0000S.102.27	28676	27 L	Ø 25	57 cm	SIYAH	6	313.40
4514.0000B.101.45	28680	45 L	Ø 31	57 cm	BEYAZ	4	413.35
4514.0000S.102.45	28681	45 L	Ø 31	57 cm	SIYAH	4	413.35

• Paslanmaz gövde



*Boyalı ürünlerde 500 Adet ve üzeri siparişlerde özel renk seçenekleri mevcuttur.

Ürünlerimiz  göre üretilmiştir.

KAPAKSIZ

Ürün Kodu	Kısa Kod	Çap	Yükseklik	Kalite	Fiyat
-----------	----------	-----	-----------	--------	-------

SS 430

4503.1823S.430.03	13288	3 L	Ø 21	19,5 cm	S.S. 430	8	61.70
4503.2026S.430.05	13289	5 L	Ø 21	24 cm	S.S. 430	8	71.70
4503.2033S.430.08	13290	8 L	Ø 21	33 cm	S.S. 430	6	88.40
4503.2433S.430.12	13291	12 L	Ø 25	33 cm	S.S. 430	6	106.70
4503.2441S.430.16	13292	16 L	Ø 25	42 cm	S.S. 430	4	133.40

SS 304

4503.1823S.304.03	13293	3 L	Ø 21	19,5 cm	S.S. 304	8	76.70
4503.2026S.304.05	13294	5 L	Ø 21	24 cm	S.S. 304	8	101.00
4503.2035S.304.08	13295	8 L	Ø 21	33 cm	S.S. 304	6	116.40
4503.2435S.304.12	13296	12 L	Ø 25	33 cm	S.S. 304	6	135.40

- Paslanmaz gövde
- Kapaksız



ÇEMBERLİ

Ürün Kodu	Kısa Kod	Çap	Yükseklik	Kalite	Fiyat
-----------	----------	-----	-----------	--------	-------

SS 430

4504.1924S.430.03	13298	3 L	Ø 21	20,5 cm	S.S. 430	8	97.00
4504.2127S.430.05	13299	5 L	Ø 21	24 cm	S.S. 430	8	109.00
4504.2034S.430.08	13300	8 L	Ø 21	33 cm	S.S. 430	6	126.70
4504.2434S.430.12	13301	12 L	Ø 25	33 cm	S.S. 430	6	152.40
4504.2442S.430.16	13302	16 L	Ø 25	42 cm	S.S. 430	4	176.20

SS 304

4504.1924S.304.03	13303	3 L	Ø 21	20,5 cm	S.S. 304	8	113.40
4504.2127S.304.05	13304	5 L	Ø 21	24 cm	S.S. 304	8	126.70
4504.2034S.304.08	13305	8 L	Ø 21	33 cm	S.S. 304	6	150.70
4504.2434S.304.12	13306	12 L	Ø 25	33 cm	S.S. 304	6	180.70

- Paslanmaz gövde
- Paslanmaz kapak



AÇIK KAPAK

Ürün Kodu	Kısa Kod	Yükseklik	Kalite	Fiyat
-----------	----------	-----------	--------	-------

SS 430

4510.2463S.430.36	28795	36 L	42 cm	S.S. 430	1	450.00
-------------------	-------	------	-------	----------	---	--------

RENKLİ BEYAZ

4510.2463B.101.36	28790	36 L	42 cm		1	466.70
-------------------	-------	------	-------	--	---	--------

RENKLİ SİYAH

4510.2463S.102.36	28791	36 L	42 cm		1	466.70
-------------------	-------	------	-------	--	---	--------



YENİ!



Ürünlerimiz  göre üretilmiştir.

*Boyalı ürünlerde 500 Adet ve üzeri siparişlerde özel renk seçenekleri mevcuttur.

SALLANIR KAPAK

Ürün Kodu	Kısa Kod	Yükseklik	Kalite	Fiyat
-----------	----------	-----------	--------	-------

SS 430

4508.1528S.430.07	13309	7 L	15x17x27 cm	S.S. 430	1	176.70
4508.1839S.430.11	13310	11 L	18x20x38 cm	S.S. 430	1	260.00
4508.1850S.430.16	13311	16 L	18x20x49 cm	S.S. 430	1	289.40
4508.2448S.430.25	13312	25 L	24x28x50 cm	S.S. 430	1	416.70
4508.2463S.430.36	13313	36 L	24x28x65 cm	S.S. 430	1	483.40
4508.3055S.430.45	13314	45 L	30x35x55 cm	S.S. 430	1	560.00
4508.3061S.430.54	13315	54 L	30x34x62 cm	S.S. 430	1	616.70
4508.3089S.430.80	13316	80 L	30x35x90 cm	S.S. 430	1	766.70

• Paslanmaz gövde

RENKLİ BEYAZ

4508.1528B.101.07	28685	7 L	15x17x27 cm		1	204.70
4508.1839B.101.11	28690	11 L	18x20x38 cm		1	287.00
4508.1850B.101.16	28695	16 L	18x20x49 cm		1	337.40
4508.2448B.101.25	28700	25 L	24x28x50 cm		1	466.70
4508.2463B.101.36	28705	36 L	24x28x65 cm		1	560.40
4508.3055B.101.45	28710	45 L	30x35x55 cm		1	645.70
4508.3061B.101.54	28715	54 L	30x34x62 cm		1	729.40
4508.3089B.101.80	28720	80 L	30x35x90 cm		1	833.40

RENKLİ SİYAH

4508.1528S.102.07	28686	7 L	15x17x27 cm		1	204.70
4508.1839S.102.11	28691	11 L	18x20x38 cm		1	287.00
4508.1850S.102.16	28696	16 L	18x20x49 cm		1	337.40
4508.2448S.102.25	28701	25 L	24x28x50 cm		1	466.70
4508.2463S.102.36	28706	36 L	24x28x65 cm		1	560.40
4508.3055S.102.45	28711	45 L	30x35x55 cm		1	645.70
4508.3061S.102.54	28716	54 L	30x34x62 cm		1	729.40
4508.3089S.102.80	28721	80 L	30x35x90 cm		1	833.40

ZARF TİPİ

Ürün Kodu	Kısa Kod	Yükseklik	Kalite	Fiyat
-----------	----------	-----------	--------	-------

SS 430

4509.3090S.430.80	28725	80 L	30x35x90 cm	S.S. 430	1	820.00
-------------------	-------	------	-------------	----------	---	--------

• Paslanmaz gövde

RENKLİ BEYAZ

4509.3090B.101.80	28727	80 L	30x35x90 cm		1	840.00
-------------------	-------	------	-------------	--	---	--------

RENKLİ SİYAH

4509.3090S.102.80	28728	80 L	30x35x90 cm		1	840.00
-------------------	-------	------	-------------	--	---	--------

Ürünlerimiz  göre üretilmiştir.

*Boyalı ürünlerde 500 Adet ve üzeri siparişlerde özel renk seçenekleri mevcuttur.

PEDALLI ÇÖP KOVALARI

STANDART BOYALI ÇÖP KOVASI

Ürün Kodu Kısa Kod Renk Çap Yükseklik Fiyat

RENKLİ 3 LİTRE

4501.1825S.101.03	18199	BEYAZ	3 L	Ø 21	22 cm	8	90.00
4501.1825S.102.03	18197	SİYAH	3 L	Ø 21	22 cm	8	90.00
4501.1825S.103.03	18200	PEMBE	3 L	Ø 21	22 cm	8	90.00
4501.1825S.104.03	18201	KIRMIZI	3 L	Ø 21	22 cm	8	90.00
4501.1825S.105.03	26817	MOR	3 L	Ø 21	22 cm	8	90.00

RENKLİ 5 LİTRE

4501.2028S.101.05	18204	BEYAZ	5 L	Ø 21	26 cm	8	96.70
4501.2028S.102.05	18202	SİYAH	5 L	Ø 21	26 cm	8	96.70
4501.2028S.103.05	18205	PEMBE	5 L	Ø 21	26 cm	8	96.70
4501.2028S.104.05	18206	KIRMIZI	5 L	Ø 21	26 cm	8	96.70
4501.2028S.105.05	26818	MOR	5 L	Ø 21	26 cm	8	96.70

RENKLİ 12 LİTRE

4501.2435S.101.12	18208	BEYAZ	12 L	Ø 25	35 cm	6	146.70
4501.2435S.102.12	18207	SİYAH	12 L	Ø 25	35 cm	6	146.70
4501.2435S.103.12	18209	PEMBE	12 L	Ø 25	35 cm	6	146.70
4501.2435S.104.12	18210	KIRMIZI	12 L	Ø 25	35 cm	6	146.70
4501.2435S.105.12	26819	MOR	12 L	Ø 25	35 cm	6	146.70



SET ÜSTÜ SIVI SABUNLUK

Ürün Kodu Kısa Kod Renk Çap Yükseklik Fiyat

PASLANMAZ SS 430

4711.17.718.1	26460		Ø 7	17 cm	20	55.00
---------------	-------	--	-----	-------	----	-------

RENKLİ

4711.18.71.B	26464	BEYAZ	Ø 7	17 cm	20	56.00
4711.18.71.S	26463	SİYAH	Ø 7	17 cm	20	56.00
4711.18.71.P	26462	PEMBE	Ø 7	17 cm	20	56.00
4711.18.71.K	26461	KIRMIZI	Ø 7	17 cm	20	56.00
4711.18.71.M	26671	MOR	Ø 7	17 cm	20	56.00



DİŞ FIRÇALIK

Ürün Kodu Kısa Kod Renk Çap Yükseklik Fiyat

PASLANMAZ SS 430

4711.22.711.1	26455		Ø 7	12 cm	20	33.40
---------------	-------	--	-----	-------	----	-------

RENKLİ

4711.22.711.B	26454	BEYAZ	Ø 7	12 cm	20	34.70
4711.22.711.S	26453	SİYAH	Ø 7	12 cm	20	34.70
4711.22.711.P	26452	PEMBE	Ø 7	12 cm	20	34.70
4711.22.711.K	26451	KIRMIZI	Ø 7	12 cm	20	34.70
4711.22.711.M	26672	MOR	Ø 7	12 cm	20	34.70



Ürünlerimiz  göre üretilmiştir.

*Boyalı ürünlerde 500 Adet ve üzeri siparişlerde özel renk seçenekleri mevcuttur.



STANDART

Ürün Kodu	Kısa Kod	Renk		Fiyat
-----------	----------	------	---	-------

SS 430 2'Lİ SET

ST.0102.430.P	26441	-	6	137.90
---------------	-------	---	---	--------



BOYALI 2'Lİ SET

ST.0402.101.B	26446	BEYAZ	6	144.00
ST.0302.102.S	26445	SİYAH	6	144.00
ST.0202.103.P	26444	PEMBE	6	144.00
ST.0102.104.K	26443	KIRMIZI	6	144.00
ST.0502.105.M	26669	MOR	6	144.00



STANDART

Ürün Kodu	Kısa Kod	Renk		Fiyat
-----------	----------	------	---	-------

SS 430 4'LÜ SET

ST.0104.430.P	26442	-	6	210.00
---------------	-------	---	---	--------



BOYALI 4'LÜ SET

ST.0404.101.B	26450	BEYAZ	6	216.70
ST.0304.102.S	26449	SİYAH	6	216.70
ST.0204.103.P	26448	PEMBE	6	216.70
ST.0104.104.K	26447	KIRMIZI	6	216.70
ST.0504.105.M	26670	MOR	6	216.70

DÜZ KAPAK

Ürün Kodu	Kısa Kod	Çap	Yükseklik	Kalite	Fiyat
-----------	----------	-----	-----------	--------	-------

SS 430



4513.2860S.430.0	13326	Ø 27	59,5 cm	S.S. 430	4 265.40
------------------	-------	------	---------	----------	----------

• Paslanmaz gövde

RENKLİ BEYAZ

4513.2860S.101.B	28730	Ø 27	59,5 cm		4 283.40
------------------	-------	------	---------	--	----------

RENKLİ SİYAH

4513.2860S.102.S	28731	Ø 27	59,5 cm		4 283.40
------------------	-------	------	---------	--	----------



BOMBE KAPAK

Ürün Kodu	Kısa Kod	Çap	Yükseklik	Kalite	Fiyat
-----------	----------	-----	-----------	--------	-------

SS 430



4512.2867S.000.00	13327	Ø 27	62 cm	S.S. 430	4 265.40
-------------------	-------	------	-------	----------	----------

• Paslanmaz gövde

RENKLİ BEYAZ

4512.2867S.101.B	28735	Ø 27	62 cm		4 283.40
------------------	-------	------	-------	--	----------

RENKLİ SİYAH

4512.2867S.102.S	28736	Ø 27	62 cm		4 283.40
------------------	-------	------	-------	--	----------



DOLAP İÇİ

Ürün Kodu	Kısa Kod	Çap	Yükseklik	Kalite	Fiyat
-----------	----------	-----	-----------	--------	-------

SS 430

4512.1240S.430.16	13317	Ø 25	29 cm	S.S. 430	12 158.40
-------------------	-------	------	-------	----------	-----------



Ürünlerimiz  göre üretilmiştir.

*Boyalı ürünlerde 500 Adet ve üzeri siparişlerde özel renk seçenekleri mevcuttur.



OFİS TİPİ FILELİ

Ürün Kodu	Kısa Kod	Çap	Yükseklik	Kalite	İkon	Fiyat
-----------	----------	-----	-----------	--------	------	-------

DKP

4505.2430S.000.00	13341	Ø 23	28 cm	Dkp	1	72.00
-------------------	-------	------	-------	-----	---	-------



- Boyalı
- Fileli



OFİS TİPİ BOYALI

Ürün Kodu	Kısa Kod	Çap	Yükseklik	Kalite	İkon	Fiyat
-----------	----------	-----	-----------	--------	------	-------

DKP

4505.2330S.000.00	13343	Ø 26	27 cm	Dkp	1	66.70
-------------------	-------	------	-------	-----	---	-------



- Boyalı
- Standart



OFİS TİPİ DELİKLİ

Ürün Kodu	Kısa Kod	Çap	Yükseklik	Kalite	İkon	Fiyat
-----------	----------	-----	-----------	--------	------	-------

DKP

4505.2330D.000.00	13344	Ø 26	27 cm	Dkp	1	72.00
-------------------	-------	------	-------	-----	---	-------



- Boyalı
- Delikli



YANMAZ

Ürün Kodu	Kısa Kod	Çap	Yükseklik	Kalite	İkon	Fiyat
-----------	----------	-----	-----------	--------	------	-------

SS 430

4507.2125S.430.08	13330	8 L Ø 21	25 cm	S.S. 430	8	111.00
-------------------	-------	----------	-------	----------	---	--------



- Paslanmaz gövde



OFİS TİPİ

Ürün Kodu	Kısa Kod	Çap	Yükseklik	Kalite	İkon	Fiyat
-----------	----------	-----	-----------	--------	------	-------

SS 430

4506.2529S.000.00	13329	Ø 21	23,50 cm	S.S. 430	8	85.70
-------------------	-------	------	----------	----------	---	-------



- Paslanmaz gövde
- Kapaksız

Ürünlerimiz  göre üretilmiştir.

*Boyalı ürünlerde 500 Adet ve üzeri siparişlerde özel renk seçenekleri mevcuttur.

STANDART KOLON KÜLLÜK

Ürün Kodu	Kısa Kod	Çap	Yükseklik	Kalite	İkon	Fiyat
-----------	----------	-----	-----------	--------	------	-------

SS 430

4418.1960S.430.00	13333	Ø 19	60 cm	S.S. 430	8	188.70
4418.2160S.430.00	13334	Ø 21	60 cm	S.S. 430	8	202.00
4418.2560S.430.00	13335	Ø 25	60 cm	S.S. 430	6	250.50
4418.2860S.430.00	13336	Ø 28	60 cm	S.S. 430	4	293.40



RENKLİ NO1

4418.1960B.101.00	28740	Ø 19	60 cm	BEYAZ	8	206.70
4418.1960S.102.00	28741	Ø 19	60 cm	SİYAH	8	206.70

RENKLİ NO2

4418.2160B.101.00	28745	Ø 21	60 cm	BEYAZ	8	220.00
4418.2160S.102.00	28746	Ø 21	60 cm	SİYAH	8	220.00

RENKLİ NO3

4418.2560B.101.00	28750	Ø 25	60 cm	BEYAZ	6	270.00
4418.2560S.102.00	28751	Ø 25	60 cm	SİYAH	6	270.00

RENKLİ NO4

4418.2860B.101.00	28755	Ø 28	60 cm	BEYAZ	4	313.40
4418.2860S.102.00	28756	Ø 28	60 cm	SİYAH	4	313.40



IZGARALI KOLON KÜLLÜK

Ürün Kodu	Kısa Kod	Çap	Yükseklik	Kalite	İkon	Fiyat
-----------	----------	-----	-----------	--------	------	-------

SS 430

4513.2860I.430.0	13331	Ø 26	60 cm	S.S. 430	6	254.70
------------------	-------	------	-------	----------	---	--------

• Paslanmaz gövde



LOBİ KÜLLÜK

Ürün Kodu	Kısa Kod	Çap	Yükseklik	Kalite	İkon	Fiyat
-----------	----------	-----	-----------	--------	------	-------

SS 430

4418.2671S.430.00	13339	Ø 26	67 cm	S.S. 430	4	242.50
-------------------	-------	------	-------	----------	---	--------

• Paslanmaz gövde



RENKLİ

4418.2671B.101.00	28760	Ø 26	67 cm	BEYAZ	4	283.40
4418.2671S.102.00	28761	Ø 26	67 cm	SİYAH	4	283.40



ŞAMPANYA KÜLLÜK



Ürün Kodu	Kısa Kod	Çap	Yükseklik	Kalite	Fiyat
SS 430					
4418.3165S.430.00	13340	Ø 32	61 cm	S.S. 430	4 236.70
• Paslanmaz gövde					
RENKLİ					
4418.3165B.101.00	28765	Ø 32	61 cm	BEYAZ	4 265.90
4418.3165S.102.00	28766	Ø 32	61 cm	SİYAH	4 265.90

BORU TİPİ KÜLLÜK



Ürün Kodu	Kısa Kod	Çap	Yükseklik	Kalite	Fiyat
SS 304					
4418.1182S.304.00	18182	Ø 10,50	83 cm	S.S. 304	4 810.00
RENKLİ BEYAZ					
4418.1182B.101.00	28780	Ø 10,50	83 cm		4 833.40
RENKLİ SİYAH					
4418.1182S.102.00	28781	Ø 10,50	83 cm		4 833.40

DEKORATİF KÜLLÜK MİNİ



Ürün Kodu	Kısa Kod	Çap	Yükseklik	Kalite	Fiyat
SS 304 MİNİ					
4419.0709M.304.00	26457	Ø 7	9 cm	S.S. 304	50 66.70
SS 304 MAXİ					
4419.0712M.304.00	26456	Ø 7	12 cm	S.S. 304	50 76.70
RENKLİ MİNİ					
4419.0709M.101.00	BEYAZ 28775	Ø 7	9 cm		50 70.00
4419.0709M.102.00	SİYAH 28776	Ø 7	9 cm		50 70.00
RENKLİ MAXİ					
4419.0712M.101.00	BEYAZ 28770	Ø 7	12 cm		20 83.40
4419.0712M.102.00	SİYAH 28771	Ø 7	12 cm		20 83.40

ÇÖP KOVALARI

MAXIFLOW

U TİPİ

Ürün Kodu	Kısa Kod	Ölçü		Fiyat
-----------	----------	------	--	-------

DKP

4505.5047S.000.00	13345	45x72,5x42 cm	1	613.40
-------------------	-------	---------------	---	--------



• Boyalı



BORU TİPİ

Ürün Kodu	Kısa Kod	Ölçü		Fiyat
-----------	----------	------	--	-------

DKP

4539.5049U.000.00	13346	45x117 cm	1	560.00
-------------------	-------	-----------	---	--------



• Boyalı



ŞAPKALI

Ürün Kodu	Kısa Kod	Ölçü		Fiyat
-----------	----------	------	--	-------

DKP

4539.5048S.000.00	13347	45x117x45 cm	1	593.40
-------------------	-------	--------------	---	--------



• Boyalı



BORU TİPİ DÜZ

Ürün Kodu	Kısa Kod	Ölçü		Fiyat
-----------	----------	------	--	-------

DKP

4505.5045S.000.00	13348	45x100 cm	1	533.40
-------------------	-------	-----------	---	--------



• Boyalı



Ürünlerimiz  göre üretilmiştir.



ŞAPKALI PASLANMAZ

Ürün Kodu	Kısa Kod	Ölçü	Fiyat
-----------	----------	------	-------

DKP + INOX

4539.5048S.430.00	27287	45x117x45 cm	578.20
-------------------	-------	--------------	--------



- Boyalı
- Paslanmaz

PASLANMAZ BAHÇE

Ürün Kodu	Kısa Kod	Ölçü	Fiyat
-----------	----------	------	-------

SS 304

4518.50745.000.00	13350	50x47x74 cm	2152.50
-------------------	-------	-------------	---------



- Paslanmaz



PASLANMAZ BAHÇE

Ürün Kodu	Kısa Kod	Ölçü	Fiyat
-----------	----------	------	-------

SS 304

4518.5099S.000.00	13349	50x48x115 cm	2152.50
-------------------	-------	--------------	---------



- Paslanmaz



ENDÜSTRİYEL ÇÖP KOVASI

Ürün Kodu	Kısa Kod	Ölçü	Fiyat
-----------	----------	------	-------

50 LT

4515.4045S.430.50	19769	40x47 cm	916.70
-------------------	-------	----------	--------

70 LT

4515.4065S.430.70	19770	40x67 cm	1026.70
-------------------	-------	----------	---------



- Paslanmaz SS 430



ZARF KAPAK 3'LÜ

Ürün Kodu	Kısa Kod	Ölçü	Kalite	Fiyat
-----------	----------	------	--------	-------

SS 430

AT.101.3430.P	18251	111x35,5x92	S.S. 430	2833.40
---------------	-------	-------------	----------	---------



- Paslanmaz gövde



ZARF KAPAK 4'LÜ

Ürün Kodu	Kısa Kod	Ölçü	Kalite	Fiyat
-----------	----------	------	--------	-------

SS 430

AT.101.4430.P	23442	148x35,5x92 cm	S.S. 430	3583.40
---------------	-------	----------------	----------	---------



- Paslanmaz gövde



ZARF KAPAK 3'LÜ

Ürün Kodu	Kısa Kod	Ölçü	Fiyat
-----------	----------	------	-------

DKP

AT.101.3100.B	23433	111x35,5x91 cm	2866.70
---------------	-------	----------------	---------



- Boyalı gövde



ZARF KAPAK 4'LÜ

Ürün Kodu	Kısa Kod	Ölçü	Fiyat
-----------	----------	------	-------

DKP

AT.101.4100.B	23443	148x35,5x91 cm	3666.70
---------------	-------	----------------	---------



- Boyalı gövde



Ürünlerimiz  göre üretilmiştir.



SALLANIR KAPAK 3'LÜ

Ürün Kodu	Kısa Kod	Ölçü	Kalite	Fiyat
-----------	----------	------	--------	-------

SS 430

AT.102.3430.P	18248	111x35,5x92 cm	S.S. 430	2733.40
---------------	-------	----------------	----------	---------



• Paslanmaz gövde



SALLANIR KAPAK KAPAK 4'LÜ

Ürün Kodu	Kısa Kod	Ölçü	Kalite	Fiyat
-----------	----------	------	--------	-------

SS 430

AT.102.4430.P	23439	148x35,5x92 cm	S.S. 430	3500.00
---------------	-------	----------------	----------	---------



• Paslanmaz gövde



SALLANIR KAPAK 3'LÜ

Ürün Kodu	Kısa Kod	Ölçü	Fiyat
-----------	----------	------	-------

DKP

AT.102.3100.B	18249	111x35,5x91 cm	2883.40
---------------	-------	----------------	---------



• Boyalı gövde



SALLANIR KAPAK 4'LÜ

Ürün Kodu	Kısa Kod	Ölçü	Fiyat
-----------	----------	------	-------

DKP

AT.102.4100.B	23440	148x35,5x91 cm	3666.70
---------------	-------	----------------	---------



• Boyalı gövde



Ürünlerimiz  göre üretilmiştir.

BOMBE KAPAK 3'LÜ

Ürün Kodu	Kısa Kod	Ölçü	Kalite	Fiyat
-----------	----------	------	--------	-------

SS 430

AT.103.3430.P	13337	102x27x69,5 cm	S.S. 430	1186.70
---------------	-------	----------------	----------	---------



- Paslanmaz gövde



BOMBE KAPAK 4'LÜ

Ürün Kodu	Kısa Kod	Ölçü	Kalite	Fiyat
-----------	----------	------	--------	-------

SS 430

AT.103.4430.P	23435	130x27x69,5 cm	S.S. 430	1500.00
---------------	-------	----------------	----------	---------



- Paslanmaz gövde



BOMBE KAPAK

Ürün Kodu	Kısa Kod	Ölçü	Fiyat
-----------	----------	------	-------

DKP 3'LÜ

AT.103.3100.B	13338	102x27x69,5 cm	1216.70
---------------	-------	----------------	---------

- Boyalı gövde



BOMBE KAPAK

Ürün Kodu	Kısa Kod	Ölçü	Fiyat
-----------	----------	------	-------

DKP 4'LÜ

AT.103.4100.B	23434	130x27x69,5 cm	1545.00
---------------	-------	----------------	---------



- Boyalı gövde



Ürünlerimiz  göre üretilmiştir.



ÇEMBERLİ KAPAK 3'LÜ

Ürün Kodu	Kısa Kod	Ölçü	Kalite	Fiyat
-----------	----------	------	--------	-------

SS 430

AT.104.3430.P	18253	113,5x31x69,5 cm	S.S. 430	1300.00
---------------	-------	------------------	----------	---------



- Paslanmaz gövde



ÇEMBERLİ KAPAK 4'LÜ

Ürün Kodu	Kısa Kod	Ölçü	Kalite	Fiyat
-----------	----------	------	--------	-------

SS 430

AT.104.4430.P	23436	150,5x31x69,5 cm	S.S. 430	1666.70
---------------	-------	------------------	----------	---------



- Paslanmaz gövde



PRATİK KAPAK 3'LÜ

Ürün Kodu	Kısa Kod	Ölçü	Kalite	Fiyat
-----------	----------	------	--------	-------

SS 430

AT.105.3430.P	18242	113,5x31x69,5 cm	S.S. 430	1466.70
---------------	-------	------------------	----------	---------



- Paslanmaz gövde



PRATİK KAPAK 4'LÜ

Ürün Kodu	Kısa Kod	Ölçü	Kalite	Fiyat
-----------	----------	------	--------	-------

SS 430

AT.105.4430.P	23437	150,5x31x69,5 cm	S.S. 430	1866.70
---------------	-------	------------------	----------	---------



- Paslanmaz gövde

Ürünlerimiz  göre üretilmiştir.

MİCRO

Ürün Kodu	Kısa Kod	Çap	Ölçü	Kalite	İkon	Fiyat
KF01.430K.36	13382	Ø 8	H.37 cm	S.S. 430	20	45.00



AKILLI KAPAK EKO

Ürün Kodu	Kısa Kod	Çap	Ölçü	Kalite	İkon	Fiyat
KF64.430K.36	27281	Ø 8	H.37 cm	S.S. 430	20	47.50
KF65.430K.36	27285	Ø 9	H.37 cm	S.S. 430	20	50.00



DÜZ KAPAK

Ürün Kodu	Kısa Kod	Çap	Ölçü	Kalite	İkon	Fiyat
KF05.430K.36	13384	Ø 8	H.37 cm	S.S. 430	20	49.80
KF06.304K.36	13383	Ø 8	H.37 cm	S.S. 304	20	55.00
KF07.304K.36	13385	Ø 9	H.37 cm	S.S. 304	20	58.40
KF08.430K.36	13386	Ø 9	H.37 cm	S.S. 430	20	52.00

ASKILI

KF15.430K.36	13400	Ø 8	H.37 cm	S.S. 430	20	54.40
KF16.304K.36	13399	Ø 8	H.37 cm	S.S. 304	20	61.00
KF17.304K.36	13401	Ø 9	H.37 cm	S.S. 304	20	63.40
KF18.430K.36	13402	Ø 9	H.37 cm	S.S. 430	20	57.00



BOMBE KAPAK

Ürün Kodu	Kısa Kod	Çap	Ölçü	Kalite	İkon	Fiyat
KF25.430K.36	13388	Ø 8	H.38 cm	S.S. 430	20	46.70
KF26.304K.36	13387	Ø 8	H.38 cm	S.S. 304	20	58.40
KF27.304K.36	13389	Ø 9	H.38 cm	S.S. 304	20	60.00
KF28.430K.36	13390	Ø 9	H.38 cm	S.S. 430	20	50.00

ASKILI

KF35.430K.36	13405	Ø 8	H.38 cm	S.S. 430	20	56.70
KF36.304K.36	13404	Ø 8	H.38 cm	S.S. 304	20	63.40
KF37.304K.36	13406	Ø 9	H.38 cm	S.S. 304	20	66.70
KF38.430K.36	13407	Ø 9	H.38 cm	S.S. 430	20	60.00



DÜZ KAPAK DELİKLİ

Ürün Kodu	Kısa Kod	Çap	Ölçü	Kalite	İkon	Fiyat
KF46.430K.36	13392 Delikli	Ø 9	H.37 cm	S.S. 430	20	57.00
KF45.304K.36	13391 Delikli	Ø 9	H.37 cm	S.S. 304	20	65.00

ASKILI

KF48.430K.36	13409 D.Askılı	Ø 9	H.37 cm	S.S. 430	20	59.40
KF47.304K.36	13408 D.Askılı	Ø 9	H.37 cm	S.S. 304	20	66.70



DELUXE

Ürün Kodu	Kısa Kod	Çap	Ölçü	Kalite	Fiyat
KF69.304K.36	28807	Ø 8	H.39 cm	S.S. 304	20 133.40



PRAMİT LÜKS

Ürün Kodu	Kısa Kod	Çap	Ölçü	Kalite	Fiyat
KF55.304K.36	13393	Ø 8	H.39 cm	S.S. 304	20 61.70

ASKILI

KF56.304K.36	13410	Ø 8	H.39 cm	S.S. 304	20 65.00
--------------	-------	-----	---------	----------	----------



BİYELİ

Ürün Kodu	Kısa Kod	Çap	Ölçü	Kalite	Fiyat
KF61.304K.36	13395	Ø 9	H.39,5 cm	S.S. 304	20 91.70



AKILLI KAPAK SİLİKON FIRÇA

Ürün Kodu	Kısa Kod	Çap	Ölçü	Kalite	Fiyat
-----------	----------	-----	------	--------	-------

LUX

KF62.304K.36	13396	Ø 8	H.37 cm	S.S. 304	12 140.00
--------------	-------	-----	---------	----------	-----------

KARE

KF63.304K.36	13397	37x8x8 cm	S.S. 304	12 196.70
--------------	-------	-----------	----------	-----------



AYAKLI WC FIRÇALIK SET

Ürün Kodu	Kısa Kod	Ölçü	Kalite	Fiyat
KF68.304K.72	13398	H.80 cm	S.S. 430	8 276.70

RENKLİ

KF68.101B.72	28802	H.80 cm	BEYAZ	8 300.00
KF68.102S.72	28803	H.80 cm	SİYAH	8 300.00



AKILLI KAPAK SİLİKONLU BOYALI FIRÇA

Ürün Kodu	Kısa Kod	Renk	Ölçü	Fiyat
KF63.101B.36	28797	Beyaz	H.37 cm	12 220.00
KF63.102S.36	28798	Siyah	H.37 cm	12 220.00



BOYALI WC FIRÇALIK

Ürün Kodu	Kısa Kod	Çap	Renk	Ölçü	Fiyat
KF90.101B.36	18236	Ø 8	Beyaz	H.37 cm	20 50.00
KF91.102S.36	18238	Ø 8	Siyah	H.37 cm	20 50.00
KF92.103P.36	18237	Ø 8	Pembe	H.37 cm	20 50.00
KF93.104K.36	18235	Ø 8	Kırmızı	H.37 cm	20 50.00
KF94.105M.36	27022	Ø 8	Mor	H.37 cm	20 50.00



HİJYENİK FIRÇA

Ürün Kodu	Kısa Kod	Fiyat
KF99.101.36	27143	BEYAZ 20 55.00
KF98.102.36	27144	SİYAH 20 55.00



*Fırça Sapı Fiyata Dahil Değildir.



HİJYENİK FIRÇA

Ürün Kodu	Kısa Kod	Çap	Ölçü	Kalite	Fiyat
EKO SAPLI					
KF97.101.36	26458	Ø 8.5	Beyaz 36x8x8 cm	S.S. 304	20 83.40
KF96.102.36	26459	Ø 8.5	Siyah 36x8x8 cm	S.S. 304	20 83.40
LÜKS SAPLI					
KF95.101.36	27376	Beyaz	36x8x8 cm	S.S. 304	20 90.00
KF94.102.36	27377	Siyah	36x8x8 cm	S.S. 304	20 90.00



Ürünlerimiz  göre üretilmiştir.



ENGELLI SERISI

ENGELLİ SERİSİ

TUTUNMA BARI

MAXIFLOW

Ürün Kodu Kısa Kod Ölçü Kalite Fiyat \varnothing 19

4819.1920P.304.00	13549	8,5x20 cm	S.S. 304	1	76.70
4819.1930P.304.00	13556	8,5x30 cm	S.S. 304	1	86.70
4819.1940P.304.00	13557	8,5x40 cm	S.S. 304	1	93.40
4819.1950P.304.00	13559	8,5x50 cm	S.S. 304	1	103.40
4819.1960P.304.00	13560	8,5x60 cm	S.S. 304	1	110.00

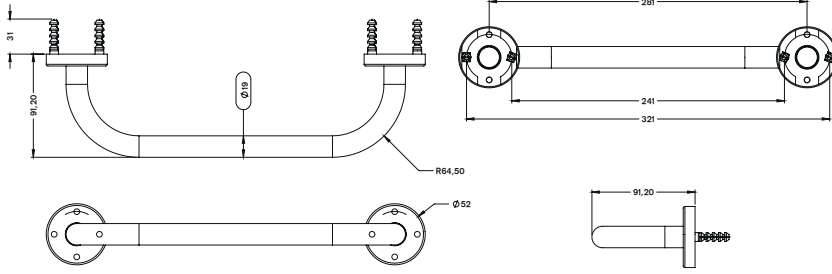

TUTUNMA BARI

Ürün Kodu Kısa Kod Ölçü Kalite Fiyat \varnothing 25

4819.2520P.304.00	13561	8,5x20 cm	S.S. 304	1	86.70
4819.2530P.304.00	13562	8,5x30 cm	S.S. 304	1	100.00
4819.2540P.304.00	13563	8,5x40 cm	S.S. 304	1	106.70
4819.2550P.304.00	13564	8,5x50 cm	S.S. 304	1	123.40
4819.2560P.304.00	13565	8,5x60 cm	S.S. 304	1	130.00

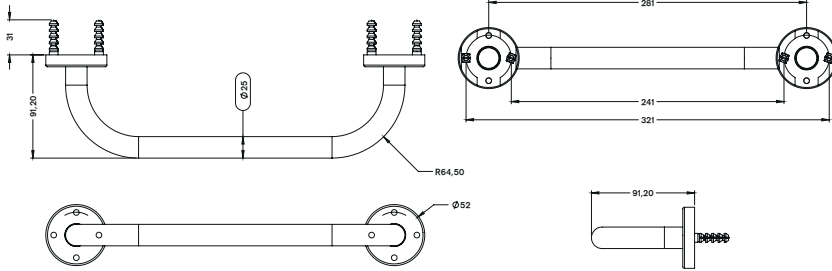

TUTUNMA BARI

Ürün Kodu Kısa Kod Ölçü Kalite Fiyat \varnothing 32

4819.3230P.304.00	13566	10,5x30 cm	S.S. 304	1	123.40
4819.3240P.304.00	13567	10,5x40 cm	S.S. 304	1	136.70
4819.3250P.304.00	13568	10,5x50 cm	S.S. 304	1	150.00
4819.3260P.304.00	13569	10,5x60 cm	S.S. 304	1	163.40

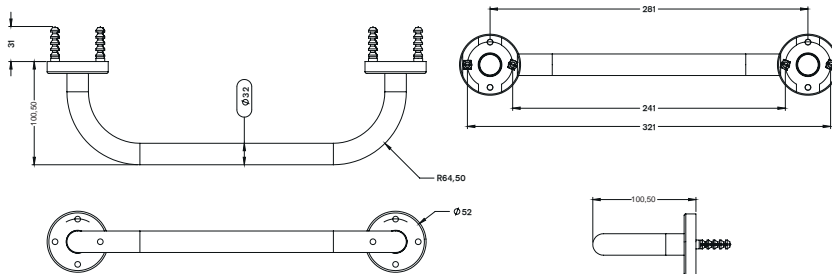

Ürünlerimiz  göre üretilmiştir.

AÇILI TUTUNMA BARI



Ürün Kodu	Kısa Kod	Ölçü	Kalite	Fiyat
4826.1950P304.00	13570	Ø 19 13x40x8,5 cm	S.S. 304	93.40
4826.2564P304.00	13571	Ø 25 13x44x8,5 cm	S.S. 304	110.00
4826.3264P304.00	13572	Ø 32 22x64x10 cm	S.S. 304	153.40

AÇILI SÜNGERLİ TUTUNMA BARI



Ürün Kodu	Kısa Kod	Ölçü	Kalite	Fiyat
4827.1950P304.00	13573	Ø 19 13x40x10 cm	S.S. 304	136.70
4827.2550P304.00	13574	Ø 25 13x44x10 cm	S.S. 304	166.70

LAVABO TUTUNMA BARI



Ürün Kodu	Kısa Kod	Ölçü	Kalite	Fiyat
4838.7080P304.00	13575	Ø 32 76x74x80 cm	S.S. 304	1066.70

ENGELLİ SERİSİ

MAFSALLI AYAKLI

Ürün Kodu	Kısa Kod	Ölçü	Kalite		Fiyat
4828.7611P304.00	13576	Ø 32 75x73 cm	S.S. 304	1	706.70

• Tutunma barı



MAFSALLI STANDART

Ürün Kodu	Kısa Kod	Ölçü	Kalite		Fiyat
4832.2311P304.00	13578	Ø 32 73x24x11 cm	S.S. 304	1	290.00

RENKLİ

4832.2311B.101.00	28808	Ø 32 73x24x11 cm	BEYAZ	1	311.70
4832.2311S.102.00	28809	Ø 32 73x24x11 cm	SİYAH	1	311.70

• Tutunma barı



MAFSALLI WC KAĞITLIKLİ

Ürün Kodu	Kısa Kod	Ölçü	Kalite		Fiyat
4833.2311P304.00	13579	Ø 32 73x24x11 cm	S.S. 304	1	323.35

RENKLİ

4833.2311B.101.00	28810	Ø 32 73x24x11 cm	BEYAZ	1	346.70
4833.2311S.102.00	28811	Ø 32 73x24x11 cm	SİYAH	1	346.70

• Tutunma barı



Ürünlerimiz



göre üretilmiştir.

MAFSALLI WC KAĞITLIKLİ

Ürün Kodu	Kısa Kod	Ölçü	Kalite	Fiyat
-----------	----------	------	--------	-------

4835.2311P304.00	13580	Ø 32 73x24x11 cm	S.S. 304	1 363.35
------------------	-------	------------------	----------	----------

RENKLİ

4835.2311B.101.00	28812	Ø 32 73x24x11 cm	BEYAZ	1 383.40
4835.2311S.102.00	28813	Ø 32 73x24x11 cm	SIYAH	1 383.40

• Tutunma barı

YERDEN DUVARA

Ürün Kodu	Kısa Kod	Ölçü	Kalite	Fiyat
-----------	----------	------	--------	-------

4834.7500P304.00	13581	Ø 32 75x75 cm	S.S. 304	1 206.70
------------------	-------	---------------	----------	----------

• Tutunma barı

YERDEN DUVARA BASTON AYAK

Ürün Kodu	Kısa Kod	Ölçü	Kalite	Fiyat
-----------	----------	------	--------	-------

4836.7500P304.00	13582	Ø 32 75x75x30 cm	S.S. 304	1 276.70
------------------	-------	------------------	----------	----------

• Döner ayaklı tutunma barı



AÇILI TUTUNMA BARI KÖŞE

Ürün Kodu	Kısa Kod	Ölçü	Kalite		Fiyat
-----------	----------	------	--------	---	-------

4831.4012P304.00	13583	Ø 32 80x40x12 cm	S.S. 304	1	276.70
------------------	-------	------------------	----------	---	--------

• Tutunma bari



L TİPİ TUTUNMA BARI

Ürün Kodu	Kısa Kod	Ölçü	Kalite		Fiyat
-----------	----------	------	--------	---	-------

4837.4012P304.00	13584	Ø 32 80x40x12cm	S.S. 304	1	253.40
------------------	-------	-----------------	----------	---	--------

• Tutunma bari



LOFT KAPI KOLU

Ürün Kodu	Kısa Kod	Ölçü	Kalite		Fiyat	Ø 25
-----------	----------	------	--------	---	-------	------

ROZETLİ

4824.2530P304.00	28965	8,5x30 cm	S.S. 304	1	96.70
4824.2540P304.00	28966	8,5x40 cm	S.S. 304	1	106.70
4824.2550P304.00	28967	8,5x50 cm	S.S. 304	1	116.70

ROZETSİZ

4823.2530P304.00	28824	8,5x30 cm	S.S. 304	1	86.70
4823.2540P304.00	28825	8,5x40 cm	S.S. 304	1	96.70
4823.2550P304.00	28826	8,5x50 cm	S.S. 304	1	106.70



YENİ!

Ürülerimiz



göre üretilmiştir.

LOFT KAPI KOLU

ÜRÜN KODU Kısa Kod Ölçü Kalite Fiyat  Ø 32

ROZETLİ

4824.3230P304.00	28968	8x30 cm	S.S. 304	1	106.70
4824.3240P304.00	28969	8x40 cm	S.S. 304	1	120.00
4824.3250P304.00	28970	8x50 cm	S.S. 304	1	130.00

ROZETSİZ

4823.3230P304.00	28827	8x30 cm	S.S. 304	1	96.70
4823.3240P304.00	28828	8x40 cm	S.S. 304	1	110.00
4823.3250P304.00	28829	8x50 cm	S.S. 304	1	120.00



YENİ!!



ROYAL KAPI KOLU

ÜRÜN KODU Kısa Kod Ölçü Kalite Fiyat  Ø 25

4822.2540P304.00	28814	8,5x40 cm	S.S. 304	1	115.00
4822.2550P304.00	28815	8,5x50 cm	S.S. 304	1	123.40
4822.2560P304.00	28816	8,5x60 cm	S.S. 304	1	136.70



YENİ!!



ROYAL KAPI KOLU

ÜRÜN KODU Kısa Kod Ölçü Kalite Fiyat  Ø 32

4822.3240P304.00	28819	8x40 cm	S.S. 304	1	150.00
4822.3250P304.00	28820	8x50 cm	S.S. 304	1	170.00
4822.3260P304.00	28821	8x60 cm	S.S. 304	1	180.00



YENİ!!



ENGELLİ SERİSİ

PLASTİK ENGELLİ DUŞ OTURAĞI

Ürün Kodu	Kısa Kod	Ölçü	Kalite	Fiyat
4820.4043S.304.00	13585	Ø 19 43x41.5x39.5 cm	S.S. 304	5 436.70



AHŞAP ENGELLİ DUŞ OTURAĞI

Ürün Kodu	Kısa Kod	Ölçü	Kalite	Fiyat
4820.4041S.304.00	13586	Ø 19 46x43.5x39 cm	S.S. 304	5 473.40



ENGELLİ AYNASI

Ürün Kodu	Kısa Kod	Ölçü	Kalite	Fiyat
4821.5070S.304.00	13587	50x70 cm	S.S. 304	5 383.40



KULPLU ENGELLİ AYNASI

Ürün Kodu	K.Kod	Ölçü	Kalite	Fiyat
4840.5070S.304.00	13588	50x70 cm	S.S. 304	5 403.40



Ürünlerimiz



göre üretilmiştir.



DUŞ SETLERİ

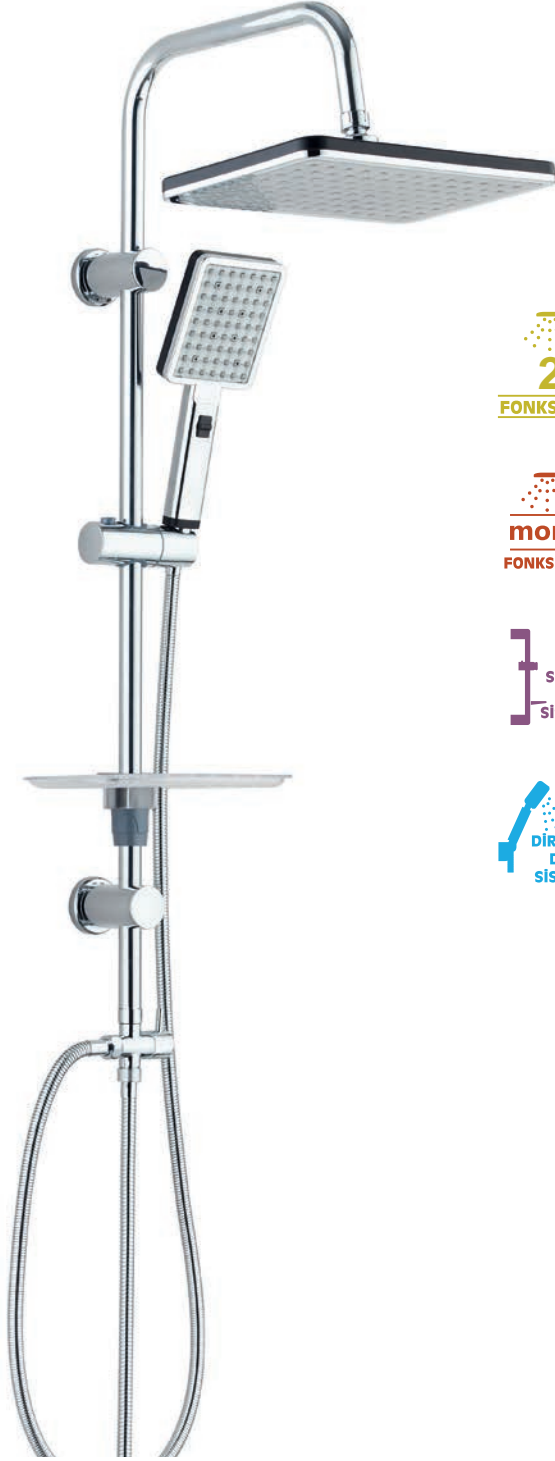

2
FONKSİYON

mono
FONKSİYON

SÜRGÜ
DUŞ
SİSTEMİ

DİRSEKLI
DUŞ
SİSTEMİ

ROBOT LONDRA

Ürün Kodu

Kısa Kod



Fiyat

4910.01150.LR.11

27654

8

775.00

22 mm çapında paslanmaz çelik kromajlı "L" biçimli boru. Duş başlıkları orijinal ABS hammaddeden üretilmiştir. 250 mm tepe duşu ve 3 fonksiyonlu özel tasarım el duşu. Su tasarruf sistemi. Kireç kırıcı duş başlıkları. ½" – ½" 150-165cm, çift kenetli, paslanmaz çelik, EPDM hortumlu, kendinden contalı ve pirinç bağlantı uçlu spiral. Ergonomik kristal sabunluk. Plastikten üretilmiş özel montaj ayağı görevi de gören krom kaplama yönlendirici. Her armatüre uyandır adaptör ve montaj elemanları. Düşük su basınçlarında mükemmel su akışı sağlar. %50'ye kadar su tasarrufu sağlar. Özel yönlendiricisi ile tepe duşu ve el duşu geçişleri çok kolaydır, sızdırma yapmaz. Montajı kolaydır.



mono
FONKSİYON

SÜRGÜ
DUŞ
SİSTEMİ

DİRSEKLI
DUŞ
SİSTEMİ

ROBOT BARCELONA

Ürün Kodu

Kısa Kod



Fiyat

4920.01150.BR.1

27655

8

700.00

22 mm çapında paslanmaz çelik kromajlı "L" biçimli boru. Duş başlıkları orijinal ABS hammaddeden üretilmiştir. 250 mm tepe duşu ve 3 fonksiyonlu özel tasarım el duşu. Su tasarruf sistemi. Kireç kırıcı duş başlıkları. ½" – ½" 150-165cm, çift kenetli, paslanmaz çelik, EPDM hortumlu, kendinden contalı ve pirinç bağlantı uçlu spiral. Ergonomik kristal sabunluk. Plastikten üretilmiş özel montaj ayağı görevi de gören krom kaplama yönlendirici. Her armatüre uyandır adaptör ve montaj elemanları. Düşük su basınçlarında mükemmel su akışı sağlar. %50'ye kadar su tasarrufu sağlar. Özel yönlendiricisi ile tepe duşu ve el duşu geçişleri çok kolaydır, sızdırma yapmaz. Montajı kolaydır.

DUŞ SETLERİ

YENİ!

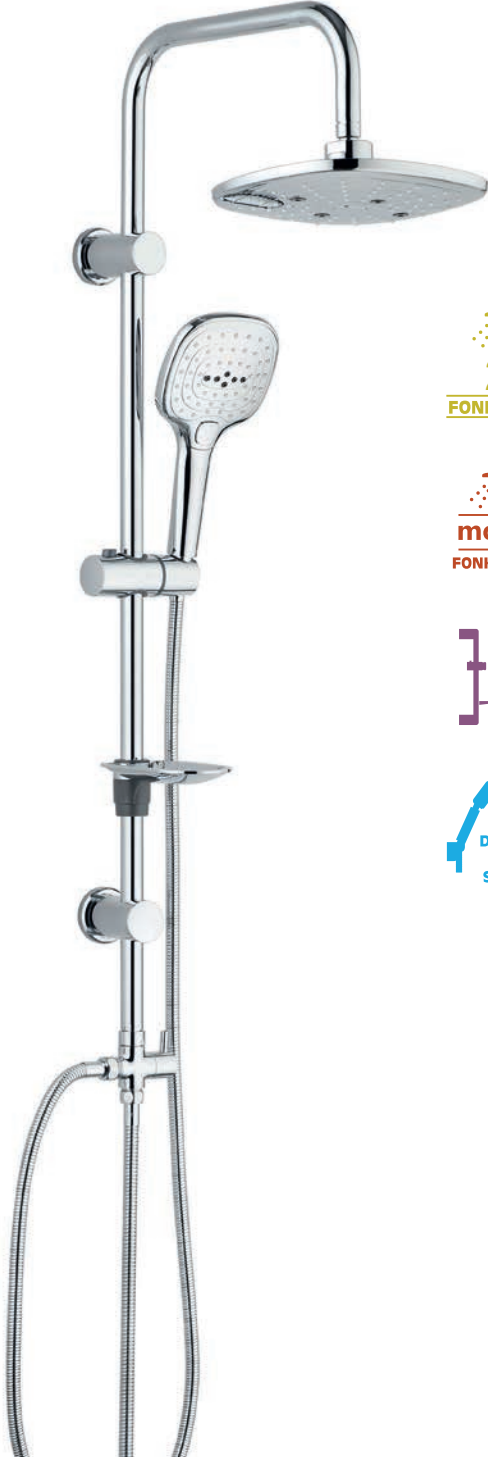

2
FONKSİYON

mono
FONKSİYON

SÜRGÜ
DUŞ
SİSTEMİ

DİRSEKLİ
DUŞ
SİSTEMİ

ROBOT PARIS

Ürün Kodu

Kısa Kod



Fiyat

4930.01150.BR.1

27656

8

650.00

22 mm çapında paslanmaz çelik kromajlı "L" biçimli boru. Duş başlıkları orijinal ABS hammaddeden üretilmiştir. 250 mm tepe duşu ve 3 fonksiyonlu özel tasarım el duşu. Su tasarruf sistemi. Kireç kırıcı duş başlıkları. ½" - ½" 150-165cm, çift kenetli, paslanmaz çelik, EPDM hortumlu, kendinden contalı ve pirinç bağlantı uçlu spiral. Ergonomik kristal sabunluk. Plastikten üretilmiş özel montaj ayağı görevi de gören krom kaplama yönlendirici. Her armatüre uyan adaptör ve montaj elemanları. Düşük su basınçlarında mükemmel su akışı sağlar. %50'ye kadar su tasarrufu sağlar. Özel yönlendiricisi ile tepe duşu ve el duşu geçişleri çok kolaydır, sızdırma yapmaz. Montajı kolaydır.

MAXIFLOW



5
FONKSİYON

mono
FONKSİYON

SÜRGÜ
DUŞ
SİSTEMİ

DİRSEKLİ
DUŞ
SİSTEMİ

ROBOT CUBA

Ürün Kodu

Kısa Kod



Fiyat

4969.01160.CR.3

26487

8

591.50

22 mm çapında paslanmaz çelik kromajlı "L" biçimli boru. Duş başlıkları orijinal ABS hammaddeden üretilmiştir. 250 mm tepe duşu ve 3 fonksiyonlu özel tasarım el duşu. Su tasarruf sistemi. Kireç kırıcı duş başlıkları. ½" - ½" 150-165cm, çift kenetli, paslanmaz çelik, EPDM hortumlu, kendinden contalı ve pirinç bağlantı uçlu spiral. Ergonomik kristal sabunluk. Plastikten üretilmiş özel montaj ayağı görevi de gören krom kaplama yönlendirici. Her armatüre uyan adaptör ve montaj elemanları. Düşük su basınçlarında mükemmel su akışı sağlar. %50'ye kadar su tasarrufu sağlar. Özel yönlendiricisi ile tepe duşu ve el duşu geçişleri çok kolaydır, sızdırma yapmaz. Montajı kolaydır.

DUŞ
SETLERİ



mono
FONKSİYON

SÜRGÜ
DUŞ
SİSTEMİ

DİRSEKLI
DUŞ
SİSTEMİ

ROBOT TOKYO

Ürün Kodu

Kısa Kod



Fiyat

04940.01150.TR.1

27657

8

525.00

22 mm çapında paslanmaz çelik kromajlı "L" biçimli boru. Duş başlıkları orijinal ABS hammaddeden üretilmiştir. 250 mm tepe duşu ve 3 fonksiyonlu özel tasarım el duşu. Su tasarruf sistemi. Kireç kırıcı duş başlıkları. ½" – ½" 150-165cm, çift kenetli, paslanmaz çelik, EPDM hortumlu, kendinden contalı ve pirinç bağlantı uçlu spiral. Ergonomik kristal sabunluk. Plastikten üretilmiş özel montaj ayağı görevi de gören krom kaplama yönlendirici. Her armatüre uyan adaptör ve montaj elemanları. Düşük su basınçlarında mükemmel su akışı sağlar. %50'ye kadar su tasarrufu sağlar. Özel yönlendiricisi ile tepe duşu ve el duşu geçişleri çok kolaydır, sızdırma yapmaz. Montajı kolaydır.



5
FONKSİYON

mono
FONKSİYON

SÜRGÜ
DUŞ
SİSTEMİ

DİRSEKLI
DUŞ
SİSTEMİ

ROBOT BERLİN

Ürün Kodu

Kısa Kod



Fiyat

4950.01150.BR.1

27658

8

500.00

22 mm çapında paslanmaz çelik kromajlı "L" biçimli boru. Duş başlıkları orijinal ABS hammaddeden üretilmiştir. 250 mm tepe duşu ve 3 fonksiyonlu özel tasarım el duşu. Su tasarruf sistemi. Kireç kırıcı duş başlıkları. ½" – ½" 150-165cm, çift kenetli, paslanmaz çelik, EPDM hortumlu, kendinden contalı ve pirinç bağlantı uçlu spiral. Ergonomik kristal sabunluk. Plastikten üretilmiş özel montaj ayağı görevi de gören krom kaplama yönlendirici. Her armatüre uyan adaptör ve montaj elemanları. Düşük su basınçlarında mükemmel su akışı sağlar. %50'ye kadar su tasarrufu sağlar. Özel yönlendiricisi ile tepe duşu ve el duşu geçişleri çok kolaydır, sızdırma yapmaz. Montajı kolaydır.

DUŞ SETLERİ

YENİ!



mono
FONKSİYON

SÜRGÜ
DUŞ
SİSTEMİ

DİRSEKLI
DUŞ
SİSTEMİ

ROBOT RIO

Ürün Kodu

Kısa Kod



Fiyat

4960.01150.RR.1

27659

8

481.00

22 mm çapında paslanmaz çelik kromajlı "L" biçimli boru. Duş başlıkları orijinal ABS hammaddeden üretilmiştir. 250 mm tepe duşu ve 3 fonksiyonlu özel tasarım el duşu. Su tasarruf sistemli. Kireç kırıcı duş başlıkları. 1/2" - 1/2" 150-165cm, çift kenetli, paslanmaz çelik, EPDM hortumlu, kendinden contalı ve piriç bağlantı uçlu spiral. Ergonomik kristal sabunluk. Plastikten üretilmiş özel montaj ayağı görevi de gören krom kaplama yönlendirici. Her armatüre uyan adaptör ve montaj elemanları. Düşük su basınçlarında mükemmel su akışı sağlar. %50'ye kadar su tasarrufu sağlar. Özel yönlendiricisi ile tepe duşu ve el duşu geçişleri çok kolaydır, sızdırma yapmaz. Montajı kolaydır.

MAXIFLOW

YENİ!



5
FONKSİYON

mono
FONKSİYON

SÜRGÜ
DUŞ
SİSTEMİ

DİRSEKLI
DUŞ
SİSTEMİ

ROBOT ROMA

Ürün Kodu

Kısa Kod



Fiyat

4970.01150.RR.1

27660

8

450.00

22 mm çapında paslanmaz çelik kromajlı "L" biçimli boru. Duş başlıkları orijinal ABS hammaddeden üretilmiştir. 250 mm tepe duşu ve 3 fonksiyonlu özel tasarım el duşu. Su tasarruf sistemli. Kireç kırıcı duş başlıkları. 1/2" - 1/2" 150-165cm, çift kenetli, paslanmaz çelik, EPDM hortumlu, kendinden contalı ve piriç bağlantı uçlu spiral. Ergonomik kristal sabunluk. Plastikten üretilmiş özel montaj ayağı görevi de gören krom kaplama yönlendirici. Her armatüre uyan adaptör ve montaj elemanları. Düşük su basınçlarında mükemmel su akışı sağlar. %50'ye kadar su tasarrufu sağlar. Özel yönlendiricisi ile tepe duşu ve el duşu geçişleri çok kolaydır, sızdırma yapmaz. Montajı kolaydır.



5
FONKSİYON

mono
FONKSİYON

SÜRGÜ
DUŞ
SİSTEMİ

DİRSEKLI
DUŞ
SİSTEMİ

ROBOT NAPOLI

Ürün Kodu Kısa Kod  Fiyat

4967.01150.PR.3 26493 8 455.10

22 mm çapında paslanmaz çelik kromajlı "L" biçimli boru. Duş başlıkları orijinal ABS hammaddeden üretilmiştir. 250 mm tepe duşu ve 3 fonksiyonlu özel tasarım el duşu. Su tasarruf sistemi. Kireç kırıcı duş başlıkları. 1/2" - 1/2" 150-165cm, çift kenetli, paslanmaz çelik, EPDM hortumlu, kendinden contalı ve pirinç bağlantı uçlu spiral. Ergonomik kristal sabunluk. Plastikten üretilmiş özel montaj ayağı görevi de gören krom kaplama yönlendirici. Her armatüre uyan adaptör ve montaj elemanları. Düşük su basınçlarında mükemmel su akışı sağlar. %50'ye kadar su tasarrufu sağlar. Özel yönlendiricisi ile tepe duşu ve el duşu geçişleri çok kolaydır, sızdırma yapmaz. Montajı kolaydır.



3
FONKSİYON

mono
FONKSİYON

SÜRGÜ
DUŞ
SİSTEMİ

DİRSEKLI
DUŞ
SİSTEMİ

ROBOT İSTANBUL

Ürün Kodu Kısa Kod  Fiyat

4980.01150.IR.1 27661 8 456.70

22 mm çapında paslanmaz çelik kromajlı "L" biçimli boru. Duş başlıkları orijinal ABS hammaddeden üretilmiştir. 250 mm tepe duşu ve 3 fonksiyonlu özel tasarım el duşu. Su tasarruf sistemi. Kireç kırıcı duş başlıkları. 1/2" - 1/2" 150-165cm, çift kenetli, paslanmaz çelik, EPDM hortumlu, kendinden contalı ve pirinç bağlantı uçlu spiral. Ergonomik kristal sabunluk. Plastikten üretilmiş özel montaj ayağı görevi de gören krom kaplama yönlendirici. Her armatüre uyan adaptör ve montaj elemanları. Düşük su basınçlarında mükemmel su akışı sağlar. %50'ye kadar su tasarrufu sağlar. Özel yönlendiricisi ile tepe duşu ve el duşu geçişleri çok kolaydır, sızdırma yapmaz. Montajı kolaydır.

YENİ!



3
FONKSİYON

mono
FONKSİYON

SÜRGÜ
DUŞ
SİSTEMİ

DİRSEKLI
DUŞ
SİSTEMİ

60
cm.

ROBOT VIYANA

Ürün Kodu

Kısa Kod



Fiyat

4968.01150.VR.3

26490

8

455.10

22 mm çapında paslanmaz çelik kromajlı "L" biçimli boru. Duş başlıkları orijinal ABS hammaddeden üretilmiştir. 250 mm tepe duşu ve 3 fonksiyonlu özel tasarım el duşu. Su tasarruf sistemi. Kireç kırıcı duş başlıkları. ½" - ½" 150-165cm, çift kenetli, paslanmaz çelik, EPDM hortumlu, kendinden contalı ve pirinç bağlantı uçlu spiral. Ergonomik kristal sabunluk. Plastikten üretilmiş özel montaj ayağı görevi de gören krom kaplama yönlendirici. Her armatüre uyan adaptör ve montaj elemanları. Düşük su basınçlarında mükemmel su akışı sağlar. %50'ye kadar su tasarrufu sağlar. Özel yönlendiricisi ile tepe duşu ve el duşu geçişleri çok kolaydır, sızdırma yapmaz. Montajı kolaydır.

YENİ!



3
FONKSİYON

mono
FONKSİYON

SÜRGÜ
DUŞ
SİSTEMİ

DİRSEKLI
DUŞ
SİSTEMİ

60
cm.

ROBOT PUMA BLACK

Ürün Kodu

Kısa Kod



Fiyat

4985.01150.PB.1

28830

8

766.70

22 mm çapında paslanmaz çelik kromajlı "L" biçimli boru. Duş başlıkları orijinal ABS hammaddeden üretilmiştir. 250 mm tepe duşu ve 3 fonksiyonlu özel tasarım el duşu. Su tasarruf sistemi. Kireç kırıcı duş başlıkları. ½" - ½" 150-165cm, çift kenetli, paslanmaz çelik, EPDM hortumlu, kendinden contalı ve pirinç bağlantı uçlu spiral. Ergonomik kristal sabunluk. Plastikten üretilmiş özel montaj ayağı görevi de gören krom kaplama yönlendirici. Her armatüre uyan adaptör ve montaj elemanları. Düşük su basınçlarında mükemmel su akışı sağlar. %50'ye kadar su tasarrufu sağlar. Özel yönlendiricisi ile tepe duşu ve el duşu geçişleri çok kolaydır, sızdırma yapmaz. Montajı kolaydır.

DUŞ SETLERİ

YENİ!



5
FONKSİYON

mono
FONKSİYON

SÜRGÜ
DUŞ
SİSTEMİ

DİRSEKLI
DUŞ
SİSTEMİ

ROBOT PANDA BLACK

Ürün Kodu Kısa Kod  Fiyat

4990.01150.KB.1 28831 8 566.70

22 mm çapında paslanmaz çelik kromajlı "L" biçimli boru. Duş başlıkları orijinal ABS hammaddeden üretilmiştir. 250 mm tepe duşu ve 3 fonksiyonlu özel tasarım el duşu. Su tasarruf sistemi. Kireç kırıcı duş başlıkları. 1/2" - 1/2" 150-165cm, çift kenetli, paslanmaz çelik, EPDM hortumlu, kendinden contalı ve pirinç bağlantı uçlu spiral. Ergonomik kristal sabunluk. Plastikten üretilmiş özel montaj ayağı görevi de gören krom kaplama yönlendirici. Her armatüre uyan adaptör ve montaj elemanları. Düşük su basınçlarında mükemmel su akışı sağlar. %50'ye kadar su tasarrufu sağlar. Özel yönlendiricisi ile tepe duşu ve el duşu geçişleri çok kolaydır, sızdırma yapmaz. Montajı kolaydır.

MAXIFLOW

YENİ!



mono
FONKSİYON

SÜRGÜ
DUŞ
SİSTEMİ

DİRSEKLI
DUŞ
SİSTEMİ

SÜRGÜLÜ PANDA BLACK

Ürün Kodu Kısa Kod  Fiyat

4912.01150.PB.2 28832 20 190.00

YENİ!



mono
FONKSİYON

SÜRGÜ
DUŞ
SİSTEMİ

DİRSEKLI
DUŞ
SİSTEMİ

MAFSALLI PANDA BLACK

Ürün Kodu Kısa Kod  Fiyat

4953.01150.PB.2 28833 28 116.70

SÜRGÜLÜ DUŞ SETLERİ

MAXIFLOW



2
FONKSİYON

SÜRGÜ
DUŞ
SİSTEMİ

DİRSEKLİ
DUŞ
SİSTEMİ

SÜRGÜLÜ LONDRA

Ürün Kodu Kısa Kod Fiyat

4911.01150.LS.2 27662 20 375.00



mono
FONKSİYON

SÜRGÜ
DUŞ
SİSTEMİ

DİRSEKLİ
DUŞ
SİSTEMİ

SÜRGÜLÜ BARCALENO

Ürün Kodu Kısa Kod Fiyat

4921.01150.BS.2 27663 20 325.00



2
FONKSİYON

SÜRGÜ
DUŞ
SİSTEMİ

DİRSEKLİ
DUŞ
SİSTEMİ

SÜRGÜLÜ PARIS

Ürün Kodu Kısa Kod Fiyat

4931.01150.PS.2 27664 20 275.00



3
FONKSİYON

SÜRGÜ
DUŞ
SİSTEMİ

DİRSEKLİ
DUŞ
SİSTEMİ

SÜRGÜLÜ CUBA

Ürün Kodu Kısa Kod Fiyat

4969.01160.CS.2 26486 20 254.30

Orijinal ABS hammaddeden üretilmiştir. Mono fonksiyon duş başlığıdır. Kireç kırıcı özelliği vardır. Spiral, 1/2" - 1/2" 150-165cm, çift kenetli, paslanmaz çelik, EPDM hortumlu, kendinden contalı ve pirinç bağlantı uçludur. Her armatüre uyan adaptör ve montaj parçaları kutu içeriğinde bulunmaktadır. Düşük su basınçlarında mükemmel su akışı sunar. %50'ye kadar su tasarrufu sağlar. Her armatüre uygundur. Montajı kolaydır.

SÜRGÜLÜ DUŞ SETLERİ

MAXIFLOW



SÜRGÜLÜ TOKYO

Ürün Kodu	Kısa Kod		Fiyat
4941.01150.BS.2	27665	20	225.00



SÜRGÜLÜ BERLİN

Ürün Kodu	Kısa Kod		Fiyat
4951.01150.BS.2	27666	20	175.00



SÜRGÜLÜ RIO

Ürün Kodu	Kısa Kod		Fiyat
4961.01150.RS.2	27667	20	162.50



SÜRGÜLÜ ROMA

Ürün Kodu	Kısa Kod		Fiyat
4971.01150.RS.2	27668	20	150.00

Orijinal ABS hammaddeden üretilmiştir. Mono fonksiyon duş başlığıdır. Kireç kırıcı özelliği vardır. Spiral, 1/2" - 1/2" 150-165cm, çift kenetli, paslanmaz çelik, EPDM hortumlu, kendinden contalı ve piriç bağlantı uçludur. Her armatüre uyan adaptör ve montaj parçaları kutu içeriğinde bulunmaktadır. Düşük su basınçlarında mükemmel su akışı sunar. %50'ye kadar su tasarrufu sağlar. Her armatüre uygundur. Montajı kolaydır.

SÜRGÜLÜ DUŞ SETLERİ



3
FONKSİYON

SÜRGÜ
DUŞ
SİSTEMİ

DİRSEKLİ
DUŞ
SİSTEMİ

SÜRGÜLÜ NAPOLİ

Ürün Kodu Kısa Kod Fiyat

4967.01150.PS.2 26492 20 156.40

MAXIFLOW



mono
FONKSİYON

SÜRGÜ
DUŞ
SİSTEMİ

DİRSEKLİ
DUŞ
SİSTEMİ

SÜRGÜLÜ VIYANA

Ürün Kodu Kısa Kod Fiyat

4968.01150.VS.2 26489 20 143.60



3
FONKSİYON

SÜRGÜ
DUŞ
SİSTEMİ

DİRSEKLİ
DUŞ
SİSTEMİ

SÜRGÜLÜ İSTANBUL

Ürün Kodu Kısa Kod Fiyat

4981.01150.IS.2 27669 20 118.75



DUŞ
SETLERİ

Orijinal ABS hammaddeden üretilmiştir. Mono fonksiyon duş başlığıdır. Kireç kırıcı özelliği vardır. Spiral, 1/2" - 1/2" 150-165cm, çift kenetli, paslanmaz çelik, EPDM hortumlu, kendinden contalı ve pirinç bağlantı uçludur. Her armatüre uyan adaptör ve montaj parçaları kutu içeriğinde bulunmaktadır. Düşük su basınçlarında mükemmel su akışı sunar. %50'ye kadar su tasarrufu sağlar. Her armatüre uygundur. Montajı kolaydır.

MAFSALLI DUŞ SETLERİ

MAXIFLOW



mono
FONKSİYON

DİRSEKLI
DUŞ
SİSTEMİ

MAFSALLI NAPOLİ

Ürün Kodu Kısa Kod  Fiyat

4967.01150.PM.1 26491 28 91.60



mono
FONKSİYON

DİRSEKLI
DUŞ
SİSTEMİ

MAFSALLI VIYANA

Ürün Kodu Kısa Kod  Fiyat

4968.01150.VM.1 26488 28 78.70



5
FONKSİYON

DİRSEKLI
DUŞ
SİSTEMİ

MAFSALLI BERLİN

Ürün Kodu Kısa Kod  Fiyat

4952.01150.BM.3 27670 28 93.75



3
FONKSİYON

DİRSEKLI
DUŞ
SİSTEMİ

MAFSALLI İSTANBUL

Ürün Kodu Kısa Kod  Fiyat

4982.01150.IM.3 27671 28 75.00



mono
FONKSİYON

DİRSEKLI
DUŞ
SİSTEMİ

MAFSALLI BAKÜ

Ürün Kodu Kısa Kod  Fiyat

4993.01150.BM.3 27672 28 68.75

Orijinal ABS hammaddeden üretilmiştir. Mono fonksiyon duş başlığıdır. Kireç kırıcı özelliği vardır. Spiral, 1/2" - 1/2" 150-165cm, çift kenetli, paslanmaz çelik, EPDM hortumlu, kendinden contalı ve piriç bağlantı uçludur. Her armatüre uyan adaptör ve montaj parçaları kutu içeriğinde bulunmaktadır. Düşük su basınçlarında mükemmel su akışı sunar. %50'ye kadar su tasarrufu sağlar. Her armatüre uygundur. Montajı kolaydır.

PANEL DUŞ SETLERİ

YENİ!



PANEL DUŞ ARAS

Ürün Kodu	Kısa Kod		Fiyat
4965.01150AP3	26324	1	2345.00

MAXIFLOW



PANEL DUŞ CEYHAN

Ürün Kodu	Kısa Kod		Fiyat
4965.01150CP2	26320	1	2000.00



PANEL DUŞ MERİÇ

Ürün Kodu	Kısa Kod		Fiyat
4965.01150MP1	26319	1	3125.00

DUŞ
SETLERİ

Ürün Kodu	Kısa Kod	Çıkış	Ölçü		Fiyat	LINE
-----------	----------	-------	------	---	-------	------

ALÇAK SEVİYELİ

4012.0Y050A.020.1	21668	Ø 50	20 cm	12	86.70
4012.0Y050A.033.1	21634	Ø 50	33 cm	12	103.40
4012.0Y050A.040.1	21645	Ø 50	40 cm	12	113.40
4012.0Y050A.050.1	21658	Ø 50	50 cm	12	126.70
4012.0Y050A.060.1	21684	Ø 50	60 cm	12	143.40

ALÇAK SEVİYELİ

4012.0A050A.020.1	21536	Ø 50	20 cm	12	86.70
4012.0A050A.033.1	21552	Ø 50	33 cm	12	103.40
4012.0A050A.040.1	21565	Ø 50	40 cm	12	113.40
4012.0A050A.050.1	21575	Ø 50	50 cm	12	126.70
4012.0A050A.060.1	21585	Ø 50	60 cm	12	143.40

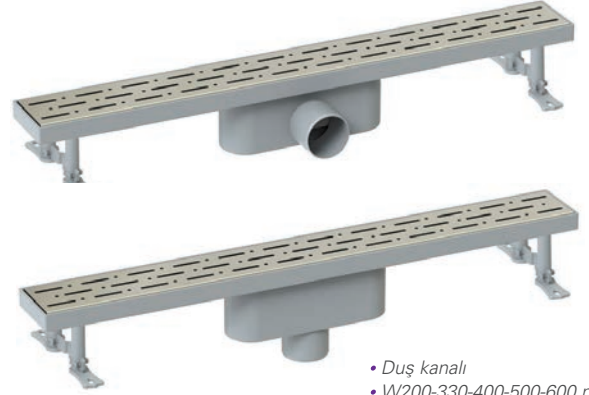

- Duş kanalı
- W200-330-400-500-600 mm
- Ø 50 yan - alt çıkış
- Plastik gövde
- Paslanmaz ızgara
- Sulu koku tutucu

Ürün Kodu	Kısa Kod	Çıkış	Ölçü		Fiyat	LINE
-----------	----------	-------	------	---	-------	------

4012.0Y050K.020.1	14414	Ø 50	20 cm	12	86.70
4012.0Y050K.033.1	14431	Ø 50	33 cm	12	103.40
4012.0Y050K.040.1	14445	Ø 50	40 cm	12	113.40
4012.0Y050K.050.1	14465	Ø 50	50 cm	12	126.70
4012.0Y050K.060.1	14474	Ø 50	60 cm	12	143.40
4012.0Y050K.080.1	14491	Ø 50	80 cm	12	170.00

4012.0A050K.020.1	14415	Ø 50	20 cm	12	86.70
4012.0A050K.033.1	14430	Ø 50	33 cm	12	103.40
4012.0A050K.040.1	14448	Ø 50	40 cm	12	113.40
4012.0A050K.050.1	14463	Ø 50	50 cm	12	126.70
4012.0A050K.060.1	14488	Ø 50	60 cm	12	143.40
4012.0A050K.080.1	14503	Ø 50	80 cm	12	170.00



- Duş kanalı
- W200-330-400-500-600-800 mm
- Ø 50 yan - alt çıkış
- Plastik gövde
- Paslanmaz ızgara
- Sulu koku tutucu

Ürün Kodu	Kısa Kod	Çıkış	Ölçü		Fiyat	LINE GOLD
-----------	----------	-------	------	---	-------	-----------

4012.0Y050G.020.1	14509	Ø 50	20 cm	12	113.40
4012.0Y050G.033.1	14523	Ø 50	33 cm	12	143.40
4012.0Y050G.040.1	14533	Ø 50	40 cm	12	156.70
4012.0Y050G.050.1	14550	Ø 50	50 cm	12	186.70
4012.0Y050G.060.1	14566	Ø 50	60 cm	12	213.40
4012.0Y050G.080.1	14585	Ø 50	80 cm	12	250.00

4012.0A050G.020.1	14526	Ø 50	20 cm	12	113.40
4012.0A050G.033.1	14545	Ø 50	33 cm	12	143.40
4012.0A050G.040.1	14570	Ø 50	40 cm	12	156.70
4012.0A050G.050.1	14586	Ø 50	50 cm	12	186.70
4012.0A050G.060.1	14600	Ø 50	60 cm	12	213.40
4012.0A050G.080.1	14623	Ø 50	80 cm	12	250.00

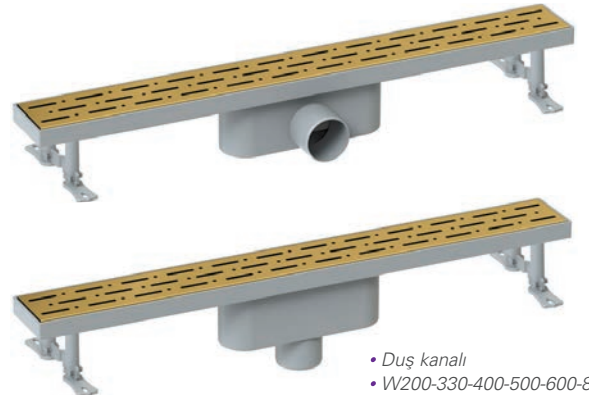

- Duş kanalı
- W200-330-400-500-600-800 mm
- Ø 50 yan - alt çıkış
- Plastik gövde
- Paslanmaz ızgara
- Sulu koku tutucu

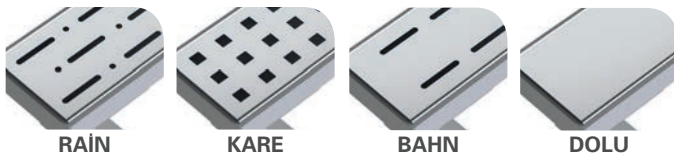

Ürünlerimiz  göre üretilmiştir.

LEGAL

Ürün Kodu	Kısa Kod	Çıkış	Ölçü	Fiyat
4013.0Y050K.020.1	14602	Ø 50	20 cm	176.70
4013.0Y050K.033.1	14613	Ø 50	33 cm	213.40
4013.0Y050K.040.1	14626	Ø 50	40 cm	236.70
4013.0Y050K.050.1	14636	Ø 50	50 cm	276.70
4013.0Y050K.060.1	14649	Ø 50	60 cm	313.40
4013.0Y050K.080.1	14668	Ø 50	80 cm	383.40

4013.0A050K.020.1	14651	Ø 50	20 cm	176.70
4013.0A050K.033.1	14667	Ø 50	33 cm	213.40
4013.0A050K.040.1	14685	Ø 50	40 cm	236.70
4013.0A050K.050.1	14701	Ø 50	50 cm	276.70
4013.0A050K.060.1	14722	Ø 50	60 cm	313.40
4013.0A050K.080.1	14734	Ø 50	80 cm	383.40



- Duş kanalı
- W200-330-400-500-600-800 mm
- Ø 50 yan - alt çıkış
- Paslanmaz gövde
- Paslanmaz ızgara
- Sulu koku tutucu

LEGAL GOLD

4013.0Y050G.020.1	14683	Ø 50	20 cm	186.70
4013.0Y050G.033.1	14702	Ø 50	33 cm	253.40
4013.0Y050G.040.1	14710	Ø 50	40 cm	286.70
4013.0Y050G.050.1	14731	Ø 50	50 cm	333.40
4013.0Y050G.060.1	14749	Ø 50	60 cm	383.40
4013.0Y050G.080.1	18284	Ø 50	80 cm	466.70

4013.0A050G.020.1	14755	Ø 50	20 cm	186.70
4013.0A050G.033.1	14778	Ø 50	33 cm	253.40
4013.0A050G.040.1	14793	Ø 50	40 cm	286.70
4013.0A050G.050.1	14813	Ø 50	50 cm	333.40
4013.0A050G.060.1	14827	Ø 50	60 cm	383.40
4013.0A050G.080.1	18351	Ø 50	80 cm	466.70

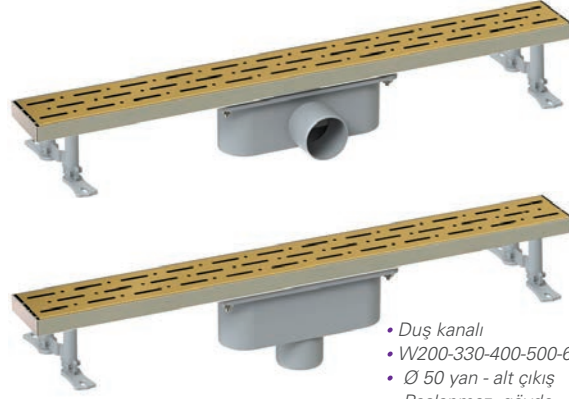

- Duş kanalı
- W200-330-400-500-600-800 mm
- Ø 50 yan - alt çıkış
- Paslanmaz gövde
- Paslanmaz ızgara
- Sulu koku tutucu

KLASİK SERİSİ

Ürün Kodu

Kısa Kod

Çıkış

Ölçü



Fiyat

LEGAL 360°

4013.00360K.020.1	14781	Ø 50	20 cm	12	180.00
4013.00360K.033.1	14797	Ø 50	33 cm	12	216.70
4013.00360K.040.1	14810	Ø 50	40 cm	12	240.00
4013.00360K.050.1	14829	Ø 50	50 cm	12	266.70
4013.00360K.060.1	14845	Ø 50	60 cm	12	300.00
4013.00360K.080.1	14859	Ø 50	80 cm	12	350.00

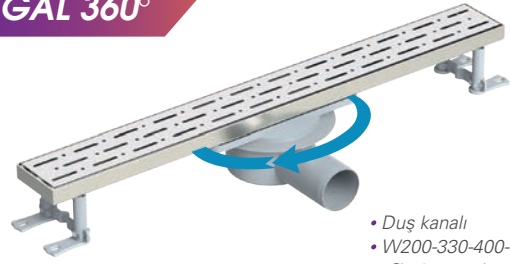

- Duş kanalı
- W200-330-400-500-600-800 mm
- Ø 50 yan çıkış
- Paslanmaz gövde
- Paslanmaz ızgara
- Sulu koku tutucu

Ürün Kodu

Kısa Kod

Çıkış

Ölçü



Fiyat

LEGAL GOLD 360°

4013.00360G.020.1	14868	Ø 50	20 cm	12	223.40
4013.00360G.033.1	14878	Ø 50	33 cm	12	266.70
4013.00360G.040.1	14892	Ø 50	40 cm	12	296.70
4013.00360G.050.1	14903	Ø 50	50 cm	12	340.00
4013.00360G.060.1	14926	Ø 50	60 cm	12	376.70
4013.00360G.080.1	14961	Ø 50	80 cm	12	466.70

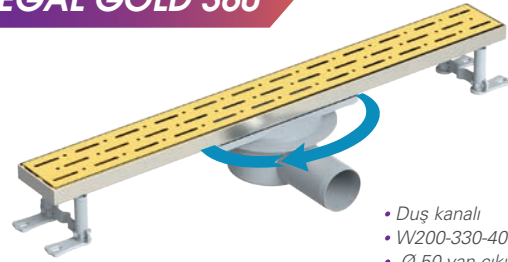

- Duş kanalı
- W200-330-400-500-600-800 mm
- Ø 50 yan çıkış
- Paslanmaz gövde
- Paslanmaz ızgara
- Sulu koku tutucu

DÜŞ
KANALLARI

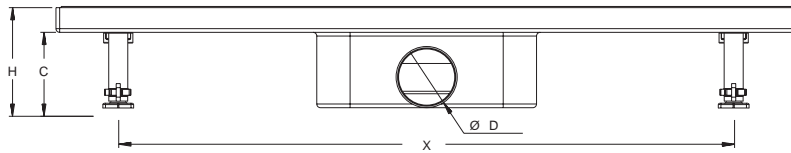
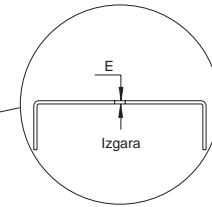
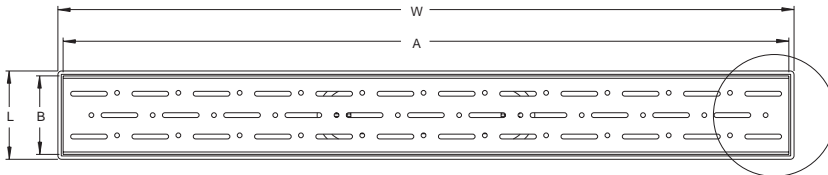

	W	L	H	Ø D	A	B	C	X	E
4012.0Y050K.020.1	205	72	88	49.5	196	64	68	-	1
4012.0Y050K.033.1	330	72	88	49.5	322	64	68	285	1
4012.0Y050K.040.1	400	72	88	49.5	392	64	68	335	1
4012.0Y050K.050.1	500	72	88	49.5	492	64	68	435	1
4012.0Y050K.060.1	600	72	88	49.5	592	64	68	556	1
4012.0Y050K.080.1	785	72	88	49.5	778	64	68	737	1

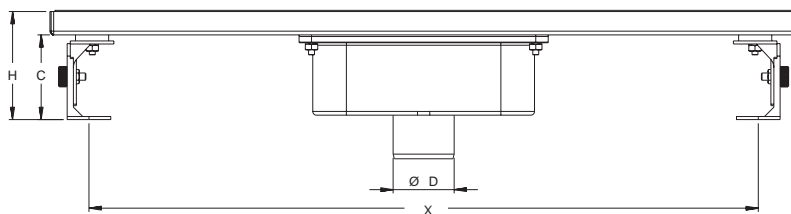

	W	L	H	Ø D	A	B	C	X	E
4012.0A050K.020.1	205	72	115	49.5	196	64	68	-	1
4012.0A050K.033.1	330	72	115	49.5	322	64	68	285	1
4012.0A050K.040.1	400	72	115	49.5	392	64	68	335	1
4012.0A050K.050.1	500	72	115	49.5	492	64	68	435	1
4012.0A050K.060.1	600	72	115	49.5	592	64	68	556	1
4012.0A050K.080.1	785	72	115	49.5	778	64	68	737	1

Tablo ölçü birimi "mm"dir.

Ürünlerimiz  göre üretilmiştir.

LEGAL Y360°

Ürün Kodu	Kısa Kod	Çıkış	Ölçü	Fiyat
4013.0Y360K.020.1	14879	Ø 50	20 cm	208.40
4013.0Y360K.033.1	14902	Ø 50	33 cm	241.70
4013.0Y360K.040.1	14916	Ø 50	40 cm	273.40
4013.0Y360K.050.1	14928	Ø 50	50 cm	286.70
4013.0Y360K.060.1	14937	Ø 50	60 cm	310.70
4013.0Y360K.080.1	14946	Ø 50	80 cm	373.40

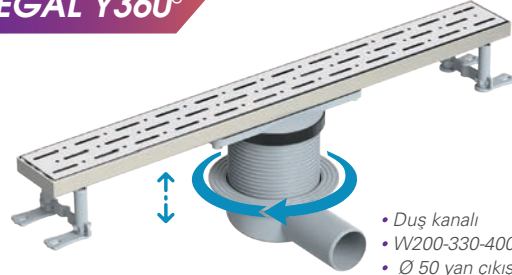

- Duş kanalı
- W200-330-400-500-600-800 mm
- Ø 50 yan çıkış
- Paslanmaz gövde
- Paslanmaz ızgara
- Sulu koku tutucu

LEGAL GOLD Y360°

Ürün Kodu	Kısa Kod	Çıkış	Ölçü	Fiyat
4013.0Y360G.020.1	14964	Ø 50	20 cm	226.70
4013.0Y360G.033.1	14980	Ø 50	33 cm	271.70
4013.0Y360G.040.1	14993	Ø 50	40 cm	286.70
4013.0Y360G.050.1	15012	Ø 50	50 cm	316.70
4013.0Y360G.060.1	15030	Ø 50	60 cm	350.00
4013.0Y360G.080.1	15057	Ø 50	80 cm	416.70

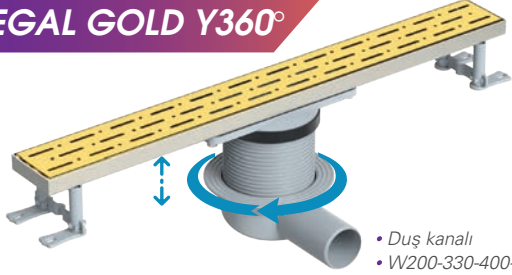

- Duş kanalı
- W200-330-400-500-600-800 mm
- Ø 50 yan çıkış
- Paslanmaz gövde
- Paslanmaz ızgara
- Sulu koku tutucu

LEGAL

Ürün Kodu	Kısa Kod	Çıkış	Ölçü	Fiyat
4013.0A360K.020.1	14971	Ø 50	20 cm	208.40
4013.0A360K.033.1	14994	Ø 50	33 cm	241.70
4013.0A360K.040.1	15007	Ø 50	40 cm	273.40
4013.0A360K.050.1	15027	Ø 50	50 cm	286.70
4013.0A360K.060.1	15038	Ø 50	60 cm	310.70
4013.0A360K.080.1	15050	Ø 50	80 cm	373.40

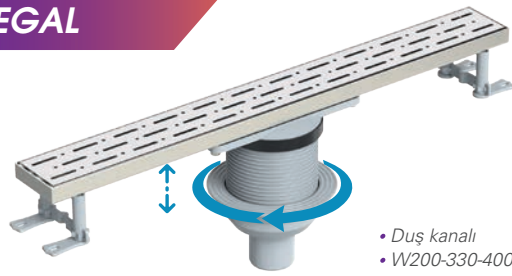

- Duş kanalı
- W200-330-400-500-600-800 mm
- Ø 50 alt çıkış
- Paslanmaz gövde
- Paslanmaz ızgara
- Sulu koku tutucu

LEGAL GOLD

Ürün Kodu	Kısa Kod	Çıkış	Ölçü	Fiyat
4013.0A360G.020.1	15064	Ø 50	20 cm	226.70
4013.0A360G.033.1	15081	Ø 50	33 cm	271.70
4013.0A360G.040.1	15097	Ø 50	40 cm	286.70
4013.0A360G.050.1	15113	Ø 50	50 cm	316.70
4013.0A360G.060.1	15126	Ø 50	60 cm	350.00
4013.0A360G.080.1	15135	Ø 50	80 cm	416.70

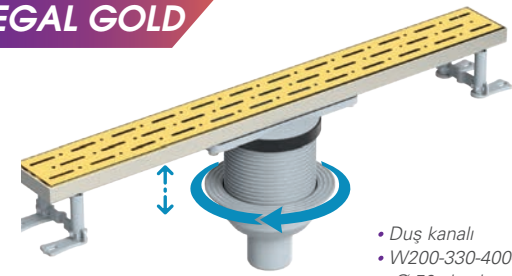

- Duş kanalı
- W200-330-400-500-600-800 mm
- Ø 50 alt çıkış
- Paslanmaz gövde
- Paslanmaz ızgara
- Sulu koku tutucu

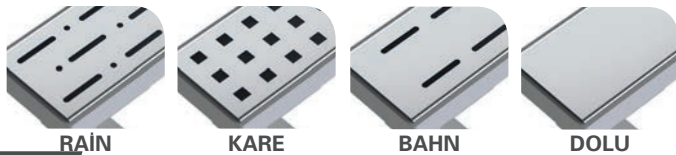

ÜRÜN KODU KISA KOD ÇIKIŞ ÖLÇÜ FİYAT SCALA

4014.0Y050K.020.1	15086	Ø 50	20 cm	12	185.00
4014.0Y050K.033.1	15087	Ø 50	33 cm	12	226.70
4014.0Y050K.040.1	15088	Ø 50	40 cm	12	243.40
4014.0Y050K.050.1	15090	Ø 50	50 cm	12	276.70
4014.0Y050K.060.1	15092	Ø 50	60 cm	12	316.70
4014.0Y050K.080.1	15095	Ø 50	80 cm	12	380.00
4014.0A050K.020.1	15072	Ø 50	20 cm	12	185.00
4014.0A050K.033.1	15076	Ø 50	33 cm	12	226.70
4014.0A050K.040.1	15078	Ø 50	40 cm	12	243.40
4014.0A050K.050.1	15080	Ø 50	50 cm	12	276.70
4014.0A050K.060.1	15082	Ø 50	60 cm	12	316.70
4014.0A050K.080.1	15084	Ø 50	80 cm	12	380.00



- Duş kanalı
- W200-330-400-500-600-800 mm
- Ø 50 yan - alt çıkış
- Paslanmaz gövde
- Paslanmaz seramik uyumlu çerçeve
- Sulu koku tutucu

ÜRÜN KODU KISA KOD ÇIKIŞ ÖLÇÜ FİYAT SCALA 360°

4014.00360K.020.1	15099	Ø 50	20 cm	12	200.00
4014.00360K.033.1	15100	Ø 50	33 cm	12	243.40
4014.00360K.040.1	15101	Ø 50	40 cm	12	266.70
4014.00360K.050.1	15103	Ø 50	50 cm	12	290.00
4014.00360K.060.1	15105	Ø 50	60 cm	12	333.40
4014.00360K.080.1	15107	Ø 50	80 cm	12	400.00
4014.0Y360K.020.1	15110	Ø 50	20 cm	12	233.40
4014.0Y360K.033.1	15112	Ø 50	33 cm	12	280.00
4014.0Y360K.040.1	15114	Ø 50	40 cm	12	313.40
4014.0Y360K.050.1	15116	Ø 50	50 cm	12	333.40
4014.0Y360K.060.1	15117	Ø 50	60 cm	12	373.40
4014.0Y360K.080.1	15118	Ø 50	80 cm	12	453.40



- Duş kanalı
- W200-330-400-500-600-800 mm
- Ø 50 yan - alt çıkış
- Paslanmaz gövde
- Paslanmaz seramik uyumlu çerçeve
- Sulu koku tutucu

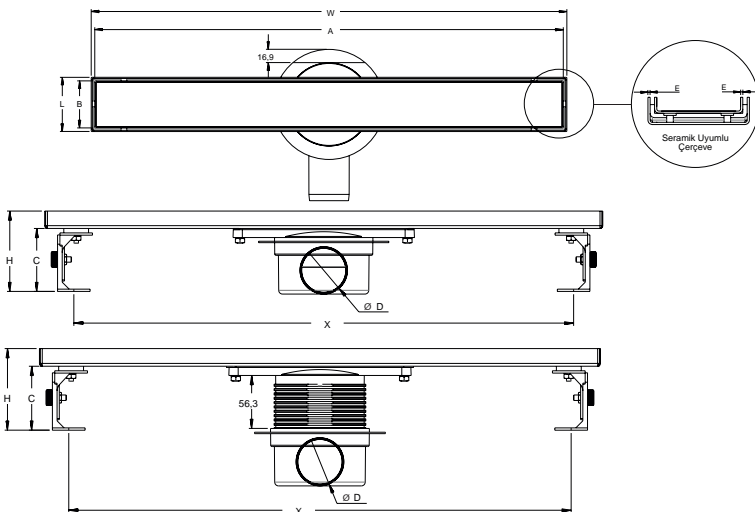

ÜRÜN KODU

ÜRÜN KODU	W	L	H	Ø D	A	B	C	X	E
4014.00360K.033.1	330	72	88	49.5	316	58	68	285	1.5
4014.00360K.040.1	400	72	88	49.5	388	58	68	335	1.5
4014.00360K.050.1	500	72	88	49.5	487	58	68	435	1.5
4014.00360K.060.1	600	72	88	49.5	589	58	68	556	1.5
4014.00360K.080.1	785	72	88	49.5	773	58	68	737	1.5

ÜRÜN KODU

ÜRÜN KODU	W	L	H	Ø D	A	B	C	X	E
4014.0Y360K.033.1	330	72	154	49.5	316	58	68	285	1.5
4014.0Y360K.040.1	400	72	154	49.5	388	58	68	335	1.5
4014.0Y360K.050.1	500	72	154	49.5	487	58	68	435	1.5
4014.0Y360K.060.1	600	72	154	49.5	589	58	68	556	1.5
4014.0Y360K.080.1	785	72	154	49.5	773	58	68	737	1.5

Tablo ölçü birimi "mm"dir.



STYLE SERİSİ

Detaylar

DN 50 Yan ve Alt çıkış – Pvc boru bağlantılarına uyumludur. Akış hızı 32 lt/dk'dır. Izgarası 304 kalite paslanmaz çeliktir.

Avantajlar

304 kalite paslanmaz çelik izgarası sayesinde şık ve kaliteli bir görünüme sahiptir. Duvar dibi uygulamalarda rahatlıkla uygulanabilir. Su tutuculu koku önleyici sayesinde tesisattan gelecek kötü kokuları önler. Yükseltme ayakları sayesinde şapın yüksekliğine göre ayarlama olanağı sağlar. Organik ve inorganik kimyasallara yüksek dayanım, çoğu asidik ve tuzlu su oksidasyonuna dayanıklıdır.

Kullanım Alanları

Genel kullanım banyo duşları, hastane ve otel duş alanları, soyunma odaları duş alanları vb.

Özel Üretim

Izgara modeli olarak isteğinize göre altın, bronz gibi renkler de üretilmektedir.

Uyarı

Yüksek yoğunluklu temizlik malzemelerinin uzun süreli kullanımı tavsiye edilmez.

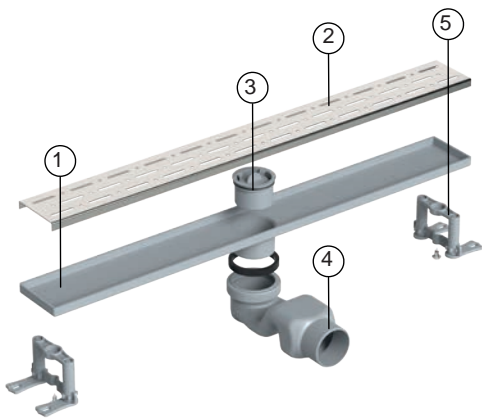

PARÇA NO	PARÇA AÇIKLAMASI	MALZEME	ADET
4083.1	Paslanmaz Üst Gövde	AISI 304	1
4083.2	Paslanmaz Izgara	AISI 304	1
4083.3	Koku Tutucu	PP	1
4083.4	S Sifon	PP	1
4083.5	Yükseklik Ayarlı Montaj Seti	PP	2

ÜRÜN KODU KISA KOD ÇIKIŞ ÖLÇÜ FİYAT SIMPLE LİNE

ÜRÜN KODU	KISA KOD	ÇIKIŞ	ÖLÇÜ	FİYAT
4080.0A050K.033.1	15119	Ø 50	33 cm	76.70
4080.0A050K.040.1	15148	Ø 50	40 cm	90.00
4080.0A050K.050.1	15162	Ø 50	50 cm	113.40
4080.0A050K.060.1	15199	Ø 50	60 cm	120.00
4080.0A050K.080.1	15216	Ø 50	80 cm	143.40



- Duş kanalı
- W200-330-400-500-600-800 mm
- Ø 50 alt çıkış
- Plastik gövde
- Paslanmaz ızgara
- Sulu koku tutucu

ÜRÜN KODU KISA KOD ÇIKIŞ ÖLÇÜ FİYAT LİNE

ÜRÜN KODU	KISA KOD	ÇIKIŞ	ÖLÇÜ	FİYAT
4081.0Y050K.033.1	15160	Ø 50	33 cm	102.70
4081.0Y050K.040.1	15172	Ø 50	40 cm	113.70
4081.0Y050K.050.1	15187	Ø 50	50 cm	126.80
4081.0Y050K.060.1	15197	Ø 50	60 cm	142.00
4081.0Y050K.080.1	15213	Ø 50	80 cm	165.70

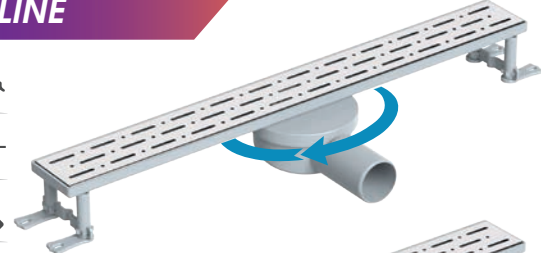

ÜRÜN KODU	KISA KOD	ÇIKIŞ	ÖLÇÜ	FİYAT
4082.0A050K.033.1	15228	Ø 50	33 cm	102.70
4082.0A050K.040.1	15239	Ø 50	40 cm	113.70
4082.0A050K.050.1	15254	Ø 50	50 cm	126.80
4082.0A050K.060.1	15269	Ø 50	60 cm	142.00
4082.0A050K.080.1	15295	Ø 50	80 cm	165.70



- Duş kanalı
- W200-330-400-500-600-800 mm
- Ø 50 alt çıkış
- Plastik gövde
- Paslanmaz ızgara
- Sulu koku tutucu

ÜRÜN KODU KISA KOD ÇIKIŞ ÖLÇÜ FİYAT STYLE SİFONİK

ÜRÜN KODU	KISA KOD	ÇIKIŞ	ÖLÇÜ	FİYAT
4083.0Y050K.033.1	15243	Ø 50	33 cm	96.70
4083.0Y050K.040.1	15270	Ø 50	40 cm	113.40
4083.0Y050K.050.1	15282	Ø 50	50 cm	126.70
4083.0Y050K.060.1	15300	Ø 50	60 cm	143.40
4083.0Y050K.080.1	15312	Ø 50	80 cm	166.70



- Duş kanalı
- W200-330-400-500-600-800 mm
- Ø 50 alt çıkış
- Plastik gövde
- Paslanmaz ızgara
- Sulu koku tutucu

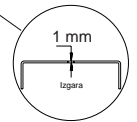
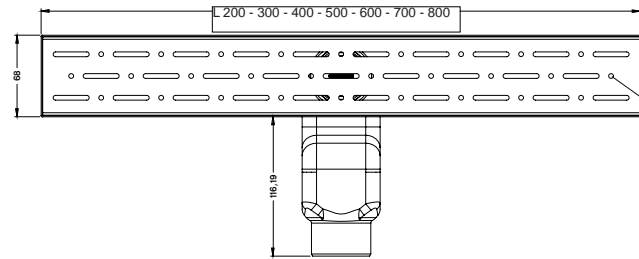
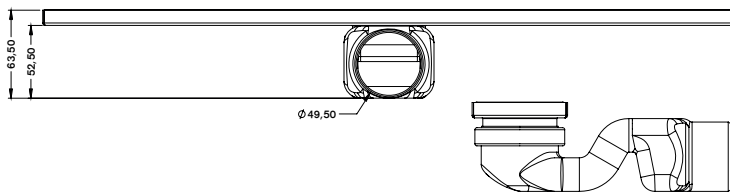

ÜRÜNLERİMİZ GÖRE ÜRETİLMİŞTİR.

ÜRÜN KODU KISA KOD ÇIKIŞ ÖLÇÜ FİYAT SIMPLE LEGAL

ÜRÜN KODU	KISA KOD	ÇIKIŞ	ÖLÇÜ	FİYAT
4086.0A050K.020.1	15329	Ø 50	20 cm	113.40
4086.0A050K.033.1	15338	Ø 50	33 cm	135.00
4086.0A050K.040.1	15347	Ø 50	40 cm	159.00
4086.0A050K.050.1	15363	Ø 50	50 cm	185.00
4086.0A050K.060.1	15381	Ø 50	60 cm	210.70
4086.0A050K.080.1	15420	Ø 50	80 cm	260.00



- Duş kanalı
- W200-330-400-500-600-800 mm
- Ø 50 alt çıkış
- Paslanmaz gövde
- Paslanmaz ızgara
- Sulu koku tutucu

ÜRÜN KODU KISA KOD ÇIKIŞ ÖLÇÜ FİYAT LEGAL

ÜRÜN KODU	KISA KOD	ÇIKIŞ	ÖLÇÜ	FİYAT
4087.0Y050K.020.1	15445	Ø 50	20 cm	130.00
4087.0Y050K.033.1	15471	Ø 50	33 cm	150.00
4087.0Y050K.040.1	15490	Ø 50	40 cm	176.70
4087.0Y050K.050.1	15508	Ø 50	50 cm	201.70
4087.0Y050K.060.1	15532	Ø 50	60 cm	226.70
4087.0Y050K.080.1	15580	Ø 50	80 cm	280.00

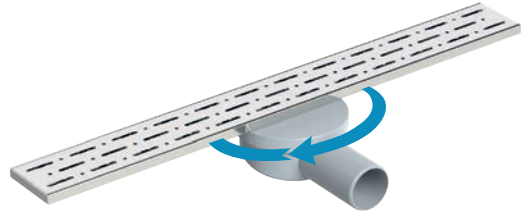

ÜRÜN KODU	KISA KOD	ÇIKIŞ	ÖLÇÜ	FİYAT
4088.0A050K.020.1	15321	Ø 50	20 cm	130.00
4088.0A050K.033.1	15366	Ø 50	33 cm	150.00
4088.0A050K.040.1	15383	Ø 50	40 cm	176.70
4088.0A050K.050.1	15396	Ø 50	50 cm	201.70
4088.0A050K.060.1	15417	Ø 50	60 cm	226.70
4088.0A050K.080.1	15446	Ø 50	80 cm	280.00



- Duş kanalı
- W200-330-400-500-600-800 mm
- Ø 50 alt çıkış
- Paslanmaz gövde
- Paslanmaz ızgara
- Sulu koku tutucu

ÜRÜN KODU KISA KOD ÇIKIŞ ÖLÇÜ FİYAT LEGAL SİFONİK

ÜRÜN KODU	KISA KOD	ÇIKIŞ	ÖLÇÜ	FİYAT
4084.0Y050K.020.1	15457	Ø 50	20 cm	125.00
4084.0Y050K.033.1	15479	Ø 50	33 cm	146.70
4084.0Y050K.040.1	15495	Ø 50	40 cm	171.70
4084.0Y050K.050.1	15517	Ø 50	50 cm	196.70
4084.0Y050K.060.1	15536	Ø 50	60 cm	225.00
4084.0Y050K.080.1	15565	Ø 50	80 cm	275.00

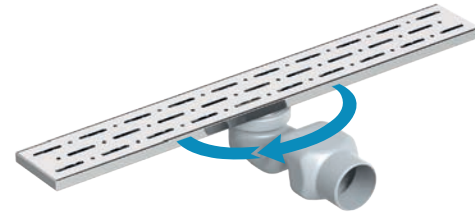

- Duş kanalı
- W200-330-400-500-600-800 mm
- Ø 50 yan çıkış
- Paslanmaz gövde
- Paslanmaz ızgara
- Sulu koku tutucu

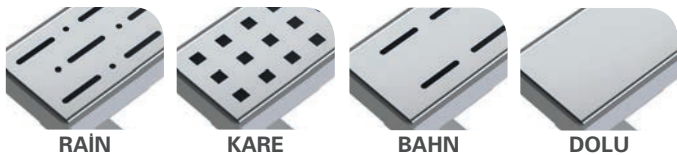

Ürünlerimiz  göre üretilmiştir.

ÜRÜN KODU KISA KOD ÇIKIŞ ÖLÇÜ FİYAT LİNE FİLELİ

ÜRÜN KODU	KISA KOD	ÇIKIŞ	ÖLÇÜ	FİYAT
4092.FY050K.033.1	15585	Ø 50	33 cm	110.00
4092.FY050K.040.1	15603	Ø 50	40 cm	121.70
4092.FY050K.050.1	15623	Ø 50	50 cm	135.00
4092.FY050K.060.1	15637	Ø 50	60 cm	151.70
4092.FY050K.080.1	15647	Ø 50	80 cm	176.70

ÜRÜN KODU	KISA KOD	ÇIKIŞ	ÖLÇÜ	FİYAT
4093.FA050K.033.1	15591	Ø 50	33 cm	110.00
4093.FA050K.040.1	15613	Ø 50	40 cm	121.70
4093.FA050K.050.1	15635	Ø 50	50 cm	135.00
4093.FA050K.060.1	15662	Ø 50	60 cm	151.70
4093.FA050K.080.1	15698	Ø 50	80 cm	176.70

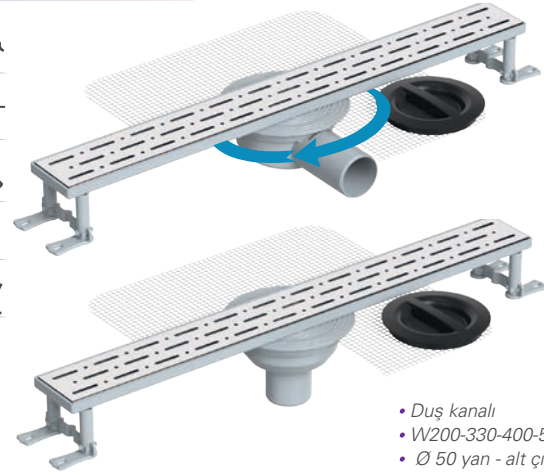

- Duş kanalı
- W200-330-400-500-600-800 mm
- Ø 50 yan - alt çıkış
- Paslanmaz gövde
- Paslanmaz ızgara
- Sulu koku tutucu

ÜRÜN KODU KISA KOD ÇIKIŞ ÖLÇÜ FİYAT LEGAL FİLELİ

ÜRÜN KODU	KISA KOD	ÇIKIŞ	ÖLÇÜ	FİYAT
4094.FY050K.020.1	15665	Ø 50	20 cm	170.00
4094.FY050K.033.1	15680	Ø 50	33 cm	200.00
4094.FY050K.040.1	15692	Ø 50	40 cm	225.00
4094.FY050K.050.1	15706	Ø 50	50 cm	255.00
4094.FY050K.060.1	15731	Ø 50	60 cm	283.40
4094.FY050K.070.1	15756	Ø 50	70 cm	313.40
4094.FY050K.080.1	15784	Ø 50	80 cm	336.70

ÜRÜN KODU	KISA KOD	ÇIKIŞ	ÖLÇÜ	FİYAT
4094.FA050K.020.1	15714	Ø 50	20 cm	170.00
4094.FA050K.033.1	15728	Ø 50	33 cm	200.00
4094.FA050K.040.1	15740	Ø 50	40 cm	225.00
4094.FA050K.050.1	15754	Ø 50	50 cm	255.00
4094.FA050K.060.1	15767	Ø 50	60 cm	283.40
4094.FA050K.070.1	19335	Ø 50	70 cm	313.40
4094.FA050K.080.1	15793	Ø 50	80 cm	336.70



- Duş kanalı
- W200-330-400-500-600-800 mm
- Ø 50 yan - alt çıkış
- Paslanmaz gövde
- Paslanmaz ızgara
- Sulu koku tutucu

ÜRÜN KODU KISA KOD ÇIKIŞ ÖLÇÜ FİYAT ALFA

ÜRÜN KODU	KISA KOD	ÇIKIŞ	ÖLÇÜ	FİYAT
4060.0A050K.040.1	28913	Ø 50	40 cm	160.00
4060.0A050K.050.1	28914	Ø 50	50 cm	181.70
4060.0A050K.060.1	28915	Ø 50	60 cm	203.40

ÜRÜN KODU	KISA KOD	ÇIKIŞ	ÖLÇÜ	FİYAT
4060.0Y050K.040.1	28919	Ø 50	40 cm	180.00
4060.0Y050K.050.1	28920	Ø 50	50 cm	200.00
4060.0Y050K.060.1	28921	Ø 50	60 cm	226.70



- Duş kanalı
- W400-500-600 mm
- Ø 50 yan - alt çıkış
- Paslanmaz gövde
- Paslanmaz ızgara
- Sulu koku tutucu

Ürünlerimiz  göre üretilmiştir.

DELUXE

Ürün Kodu	Kısa Kod	Çıkış	Ölçü	Fiyat
4061.0A050K.040.1	28916	Ø 50	40 cm	180.00
4061.0A050K.050.1	28917	Ø 50	50 cm	206.70
4061.0A050K.060.1	28918	Ø 50	60 cm	233.40
4061.0Y050K.040.1	28922	Ø 50	40 cm	200.00
4061.0Y050K.050.1	28923	Ø 50	50 cm	226.70
4061.0Y050K.060.1	28924	Ø 50	60 cm	256.70



- Duş kanalı
- W400-500-600 mm
- Ø 50 yan - alt çıkış
- Paslanmaz gövde
- Paslanmaz ızgara
- Sulu koku tutucu

VEGA

Ürün Kodu	Kısa Kod	Çıkış	Ölçü	Fiyat
4074.0A050K.040.1	15802	Ø 50	40 cm	146.70
4074.0A050K.050.1	15812	Ø 50	50 cm	163.40
4074.0A050K.060.1	15821	Ø 50	60 cm	180.00



- Duş kanalı
- W200-330-400-500-600-800 mm
- Ø 50 alt çıkış
- Paslanmaz gövde
- Paslanmaz ızgara
- Sulu koku tutucu

VEGA

Ürün Kodu	Kısa Kod	Çıkış	Ölçü	Fiyat
4075.0Y050K.040.1	15830	Ø 50	40 cm	175.00
4075.0Y050K.050.1	15843	Ø 50	50 cm	183.40
4075.0Y050K.060.1	15858	Ø 50	60 cm	200.00



- Duş kanalı
- W200-330-400-500-600-800 mm
- Ø 50 alt çıkış
- Paslanmaz gövde
- Paslanmaz ızgara
- Sulu koku tutucu

Ürün Kodu	Kısa Kod	Çıkış	Ölçü	Fiyat
4075.0A050K.040.1	15835	Ø 50	40 cm	175.00
4075.0A050K.050.1	15856	Ø 50	50 cm	183.40
4075.0A050K.060.1	15871	Ø 50	60 cm	200.00

VEGA SİFONİK

Ürün Kodu	Kısa Kod	Çıkış	Ölçü	Fiyat
4076.0Y050K.040.1	15882	Ø 50	40 cm	156.70
4076.0Y050K.050.1	15911	Ø 50	50 cm	170.00
4076.0Y050K.060.1	15925	Ø 50	60 cm	186.70



- Duş kanalı
- W200-330-400-500-600-800 mm
- Ø 50 yan çıkış
- Paslanmaz gövde
- Paslanmaz ızgara
- Sulu koku tutucu

Ürünlerimiz  göre üretilmiştir.

ÜRÜN KODU KISA KOD ÇIKIŞ ÖLÇÜ FİYAT VEGA LUX

4077.0A050K.040.1	15886	Ø 50	40 cm	12	173.40
4077.0A050K.050.1	15901	Ø 50	50 cm	12	193.40
4077.0A050K.060.1	15917	Ø 50	60 cm	12	210.00



- Duş kanalı
- W200-330-400-500-600-800 mm
- Ø 50 alt çıkış
- Paslanmaz gövde
- Paslanmaz ızgara
- Sulu koku tutucu

ÜRÜN KODU KISA KOD ÇIKIŞ ÖLÇÜ FİYAT VEGA LUX

4078.0Y050K.040.1	15935	Ø 50	40 cm	12	193.40
4078.0Y050K.050.1	15952	Ø 50	50 cm	12	213.40
4078.0Y050K.060.1	15961	Ø 50	60 cm	12	240.00

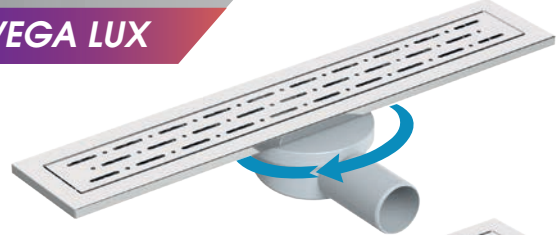

- Duş kanalı
- W200-330-400-500-600-800 mm
- Ø 50 yan - alt çıkış
- Paslanmaz gövde
- Paslanmaz ızgara
- Sulu koku tutucu

4078.0A050K.040.1	15943	Ø 50	40 cm	12	193.40
4078.0A050K.050.1	16046	Ø 50	50 cm	12	213.40
4078.0A050K.060.1	16071	Ø 50	60 cm	12	240.00

ÜRÜN KODU KISA KOD ÇIKIŞ ÖLÇÜ FİYAT VEGA LUX SİFONİK

4079.0Y050K.040.1	15971	Ø 50	40 cm	12	181.70
4079.0Y050K.050.1	15981	Ø 50	50 cm	12	200.00
4079.0Y050K.060.1	15991	Ø 50	60 cm	12	216.70



- Duş kanalı
- W400-500-600 mm
- Ø 50 yan çıkış
- Paslanmaz gövde
- Paslanmaz ızgara
- Sulu koku tutucu

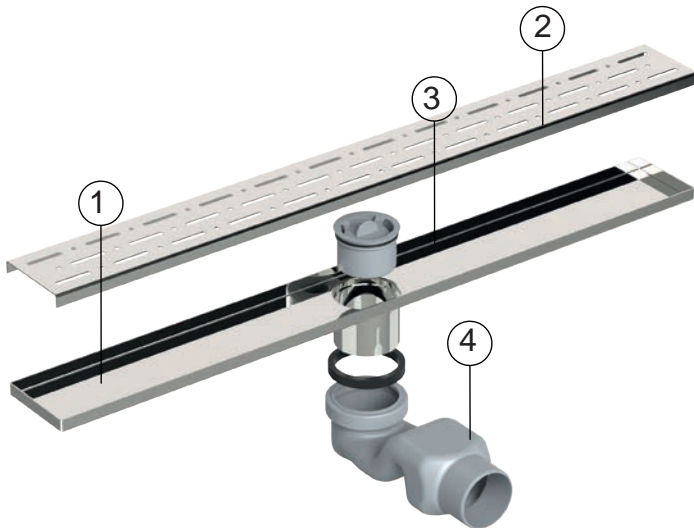

PARÇA NO	PARÇA AÇIKLAMASI	MALZEME	ADET
4079.1	Paslanmaz Üst Gövde	AISI 304	1
4079.2	Paslanmaz Izgara	AISI 304	1
4079.3	Koku Tutucu	PP	1
4079.4	S Sifon	PP	1

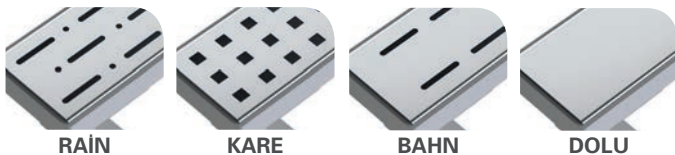

Ürünlerimiz göre üretilmiştir.

Ürün Kodu

Kısa Kod

Çıkış

Ölçü



Fiyat

VEGA FİLELİ

4075.FY050K.040.1	16002	Ø 50	40 cm	12	188.40
4075.FY050K.050.1	16011	Ø 50	50 cm	12	213.40
4075.FY050K.060.1	16020	Ø 50	60 cm	12	233.40

4075.FA050K.040.1	16031	Ø 50	40 cm	12	188.40
4075.FA050K.050.1	16051	Ø 50	50 cm	12	213.40
4075.FA050K.060.1	16066	Ø 50	60 cm	12	233.40



- Duş kanalı
- W200-330-400-500-600-800 mm
- Ø 50 yan - alt çıkış
- Paslanmaz gövde
- Paslanmaz ızgara
- Sulu koku tutucu

Ürün Kodu

Kısa Kod

Çıkış

Ölçü



Fiyat

VEGA LUX FİLELİ

4078.FY050K.040.1	16083	Ø 50	40 cm	12	226.70
4078.FY050K.050.1	16094	Ø 50	50 cm	12	246.70
4078.FY050K.060.1	16117	Ø 50	60 cm	12	263.40

4078.FA050K.040.1	16086	Ø 50	40 cm	12	226.70
4078.FA050K.050.1	16109	Ø 50	50 cm	12	246.70
4078.FA050K.060.1	16143	Ø 50	60 cm	12	263.40



- Duş kanalı
- W200-330-400-500-600-800 mm
- Ø 50 yan çıkış
- Paslanmaz gövde
- Paslanmaz ızgara
- Sulu koku tutucu

Ürün Kodu

Kısa Kod

Çıkış

Ölçü



Fiyat

LİNE

3152.0Y050K.033.1	26499	Ø 50	30 cm	12	93.40
3152.0Y050K.040.1	26500	Ø 50	40 cm	12	105.00
3152.0Y050K.050.1	26501	Ø 50	50 cm	12	117.40
3152.0Y050K.060.1	26502	Ø 50	60 cm	12	130.00
3152.0Y050K.080.1	26503	Ø 50	80 cm	12	152.40

3152.0A050K.033.1	26494	Ø 50	30 cm	12	93.40
3152.0A050K.040.1	26495	Ø 50	40 cm	12	105.00
3152.0A050K.050.1	26496	Ø 50	50 cm	12	117.40
3152.0A050K.060.1	26497	Ø 50	60 cm	12	130.00
3152.0A050K.080.1	26498	Ø 50	80 cm	12	152.40

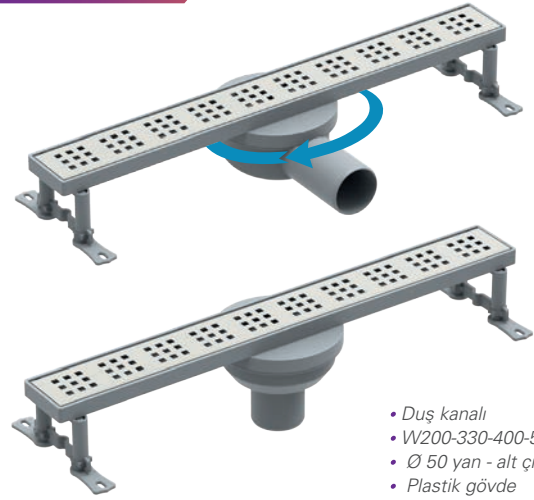

- Duş kanalı
- W200-330-400-500-600-800 mm
- Ø 50 yan - alt çıkış
- Plastik gövde
- Paslanmaz ızgara
- Sulu koku tutucu

Ürün Kodu

Kısa Kod

Çıkış

Ölçü



Fiyat

LİNE

3153.0Y050K.033.1	26509	Ø 50	30 cm	12	93.40
3153.0Y050K.040.1	26510	Ø 50	40 cm	12	105.00
3153.0Y050K.050.1	26511	Ø 50	50 cm	12	116.40
3153.0Y050K.060.1	26512	Ø 50	60 cm	12	130.00
3153.0Y050K.080.1	26513	Ø 50	80 cm	12	152.40

3153.0A050K.033.1	26504	Ø 50	30 cm	12	93.40
3153.0A050K.040.1	26505	Ø 50	40 cm	12	105.00
3153.0A050K.050.1	26506	Ø 50	50 cm	12	116.40
3153.0A050K.060.1	26507	Ø 50	60 cm	12	130.00
3153.0A050K.080.1	26508	Ø 50	80 cm	12	152.40

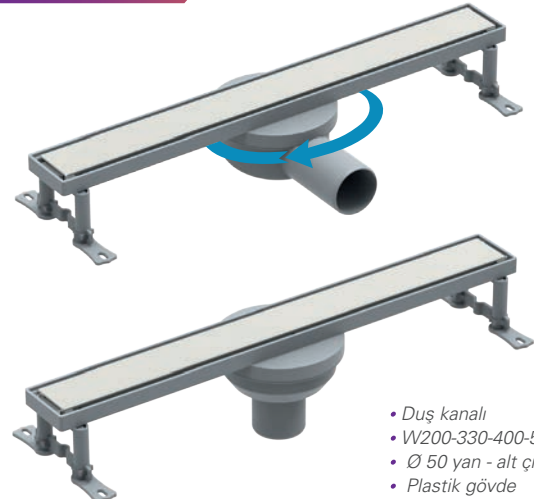

- Duş kanalı
- W200-330-400-500-600-800 mm
- Ø 50 yan - alt çıkış
- Plastik gövde
- Paslanmaz ızgara
- Sulu koku tutucu

Ürün Kodu

Kısa Kod

Çıkış

Ölçü



Fiyat

LİNE

3154.0Y050K.033.1	26519	Ø 50	30 cm	12	93.40
3154.0Y050K.040.1	26520	Ø 50	40 cm	12	105.00
3154.0Y050K.050.1	26521	Ø 50	50 cm	12	117.40
3154.0Y050K.060.1	26522	Ø 50	60 cm	12	130.00
3154.0Y050K.080.1	26523	Ø 50	80 cm	12	152.40

3154.0A050K.033.1	26514	Ø 50	30 cm	12	93.40
3154.0A050K.040.1	26515	Ø 50	40 cm	12	105.00
3154.0A050K.050.1	26516	Ø 50	50 cm	12	117.40
3154.0A050K.060.1	26517	Ø 50	60 cm	12	130.00
3154.0A050K.080.1	26518	Ø 50	80 cm	12	152.40

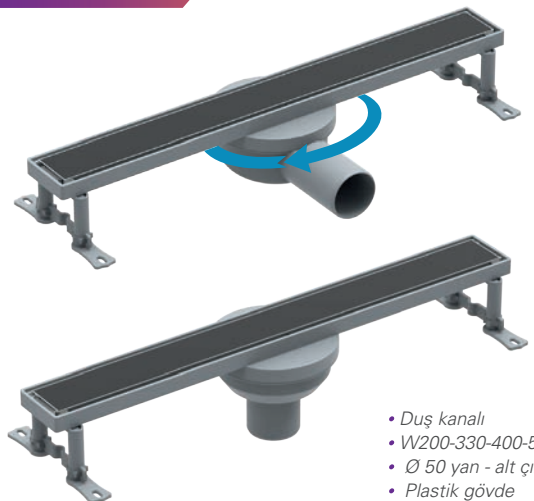

- Duş kanalı
- W200-330-400-500-600-800 mm
- Ø 50 yan - alt çıkış
- Plastik gövde
- Paslanmaz ızgara
- Sulu koku tutucu

Ürünlerimiz



göre üretilmiştir.

ÜRÜN KODU KISA KOD ÇIKIŞ ÖLÇÜ FİYAT LINE

3155.0Y050K.033.1	26529	Ø 50	30 cm	12	102.00
3155.0Y050K.040.1	26530	Ø 50	40 cm	12	115.00
3155.0Y050K.050.1	26531	Ø 50	50 cm	12	132.00
3155.0Y050K.060.1	26532	Ø 50	60 cm	12	145.40
3155.0Y050K.080.1	26533	Ø 50	80 cm	12	171.70

3155.0A050K.033.1	26524	Ø 50	30 cm	12	102.00
3155.0A050K.040.1	26525	Ø 50	40 cm	12	115.00
3155.0A050K.050.1	26526	Ø 50	50 cm	12	132.00
3155.0A050K.060.1	26527	Ø 50	60 cm	12	145.40
3155.0A050K.080.1	26528	Ø 50	80 cm	12	171.70

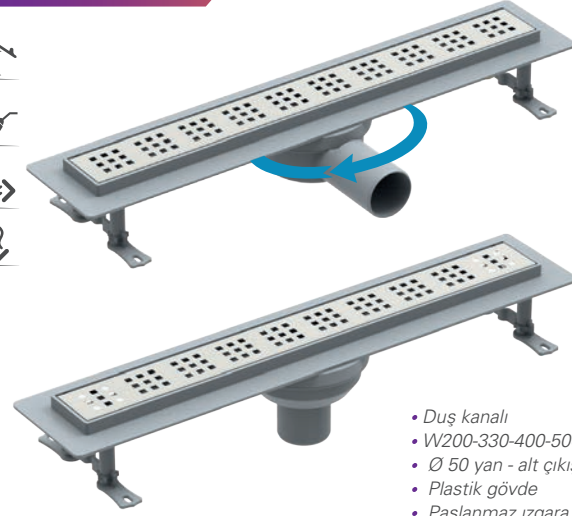

- Duş kanalı
- W200-330-400-500-600-800 mm
- Ø 50 yan - alt çıkış
- Plastik gövde
- Paslanmaz ızgara
- Sulu koku tutucu

ÜRÜN KODU KISA KOD ÇIKIŞ ÖLÇÜ FİYAT LINE FILELİ

3155.FY050K.033.1	27366	Ø 50	30 cm	12	105.00
3155.FY050K.040.1	27367	Ø 50	40 cm	12	119.70
3155.FY050K.050.1	27368	Ø 50	50 cm	12	142.40
3155.FY050K.060.1	37369	Ø 50	60 cm	12	151.40
3155.FY050K.080.1	37370	Ø 50	80 cm	12	178.40

3155.FA050K.033.1	27371	Ø 50	30 cm	12	105.00
3155.FA050K.040.1	37372	Ø 50	40 cm	12	119.70
3155.FA050K.050.1	37373	Ø 50	50 cm	12	142.40
3155.FA050K.060.1	37374	Ø 50	60 cm	12	151.40
3155.FA050K.080.1	37375	Ø 50	80 cm	12	178.40



- Duş kanalı
- W200-330-400-500-600-800 mm
- Ø 50 yan - alt çıkış
- Plastik gövde
- Paslanmaz ızgara
- Sulu koku tutucu

ÜRÜN KODU KISA KOD ÇIKIŞ ÖLÇÜ FİYAT LINE

3156.0Y050K.033.1	26549	Ø 50	30 cm	12	102.00
3156.0Y050K.040.1	26550	Ø 50	40 cm	12	115.00
3156.0Y050K.050.1	26551	Ø 50	50 cm	12	131.70
3156.0Y050K.060.1	26552	Ø 50	60 cm	12	145.40
3156.0Y050K.080.1	26553	Ø 50	80 cm	12	172.00

3156.0A050K.033.1	26544	Ø 50	30 cm	12	102.00
3156.0A050K.040.1	26545	Ø 50	40 cm	12	115.00
3156.0A050K.050.1	26546	Ø 50	50 cm	12	131.70
3156.0A050K.060.1	26547	Ø 50	60 cm	12	145.40
3156.0A050K.080.1	26548	Ø 50	80 cm	12	172.00



- Duş kanalı
- W200-330-400-500-600-800 mm
- Ø 50 yan - alt çıkış
- Plastik gövde
- Paslanmaz ızgara
- Sulu koku tutucu

ÜRÜN KODU KISA KOD ÇIKIŞ ÖLÇÜ FİYAT LİNE

ÜRÜN KODU	KISA KOD	ÇIKIŞ	ÖLÇÜ	FİYAT
3157.0Y050K.033.1	26569	Ø 50	30 cm	102.00
3157.0Y050K.040.1	26570	Ø 50	40 cm	115.00
3157.0Y050K.050.1	26571	Ø 50	50 cm	131.70
3157.0Y050K.060.1	26572	Ø 50	60 cm	145.40
3157.0Y050K.080.1	26575	Ø 50	80 cm	172.00
3157.0A050K.033.1	26564	Ø 50	30 cm	102.00
3157.0A050K.040.1	26565	Ø 50	40 cm	115.00
3157.0A050K.050.1	26566	Ø 50	50 cm	131.70
3157.0A050K.060.1	26567	Ø 50	60 cm	145.40
3157.0A050K.080.1	26568	Ø 50	80 cm	172.00



- Duş kanalı
- W200-330-400-500-600-800 mm
- Ø 50 yan - alt çıkış
- Plastik gövde
- Paslanmaz seramik uyumlu ızgara
- Sulu koku tutucu

ÜRÜN KODU KISA KOD ÇIKIŞ ÖLÇÜ FİYAT LEGAL

ÜRÜN KODU	KISA KOD	ÇIKIŞ	ÖLÇÜ	FİYAT
3158.0Y050K.033.1	26595	Ø 50	30 cm	149.00
3158.0Y050K.040.1	26596	Ø 50	40 cm	172.00
3158.0Y050K.050.1	26597	Ø 50	50 cm	196.00
3158.0Y050K.060.1	26598	Ø 50	60 cm	219.40
3158.0Y050K.080.1	26599	Ø 50	80 cm	264.00
3158.0A050K.033.1	26587	Ø 50	30 cm	149.00
3158.0A050K.040.1	26588	Ø 50	40 cm	172.00
3158.0A050K.050.1	26592	Ø 50	50 cm	196.00
3158.0A050K.060.1	26593	Ø 50	60 cm	219.40
3158.0A050K.080.1	26594	Ø 50	80 cm	264.00

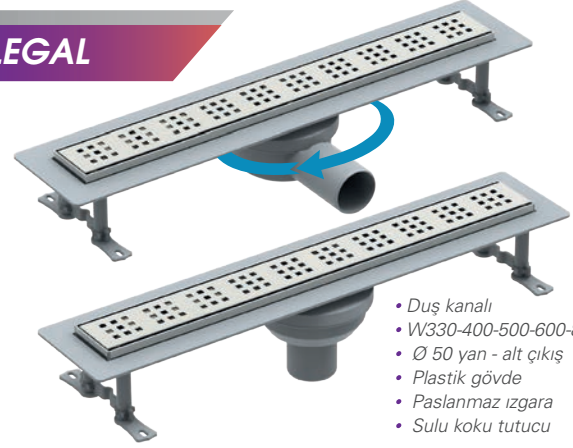

- Duş kanalı
- W330-400-500-600-800 mm
- Ø 50 yan - alt çıkış
- Plastik gövde
- Paslanmaz ızgara
- Sulu koku tutucu

ÜRÜN KODU KISA KOD ÇIKIŞ ÖLÇÜ FİYAT DELUXE

ÜRÜN KODU	KISA KOD	ÇIKIŞ	ÖLÇÜ	FİYAT
3163.0Y050K.033.1	28952	Ø 50	30 cm	192.40
3163.0Y050K.040.1	28953	Ø 50	40 cm	215.70
3163.0Y050K.050.1	28954	Ø 50	50 cm	247.00
3163.0Y050K.060.1	28955	Ø 50	60 cm	280.00
3163.0Y050K.080.1	28956	Ø 50	80 cm	339.40
3163.0A050K.033.1	28957	Ø 50	30 cm	192.40
3163.0A050K.040.1	28958	Ø 50	40 cm	215.70
3163.0A050K.050.1	28959	Ø 50	50 cm	247.00
3163.0A050K.060.1	28960	Ø 50	60 cm	280.00
3163.0A050K.080.1	28961	Ø 50	80 cm	339.40



- Duş kanalı
- W200-330-400-500-600-800 mm
- Ø 50 yan - alt çıkış
- Plastik gövde
- Paslanmaz ızgara
- Sulu koku tutucu

YENİ!

ÜRÜN KODU KISA KOD ÇIKIŞ ÖLÇÜ FİYAT LUX LEGAL

ÜRÜN KODU	KISA KOD	ÇIKIŞ	ÖLÇÜ	FİYAT
3162.0Y050K.033.1	28942	Ø 50	30 cm	156.40
3162.0Y050K.040.1	28943	Ø 50	40 cm	179.70
3162.0Y050K.050.1	28944	Ø 50	50 cm	205.40
3162.0Y050K.060.1	28945	Ø 50	60 cm	228.70
3162.0Y050K.080.1	28946	Ø 50	80 cm	273.40
3162.0A050K.033.1	28947	Ø 50	30 cm	156.40
3162.0A050K.040.1	28948	Ø 50	40 cm	179.70
3162.0A050K.050.1	28949	Ø 50	50 cm	205.40
3162.0A050K.060.1	28950	Ø 50	60 cm	228.70
3162.0A050K.080.1	28951	Ø 50	80 cm	273.40

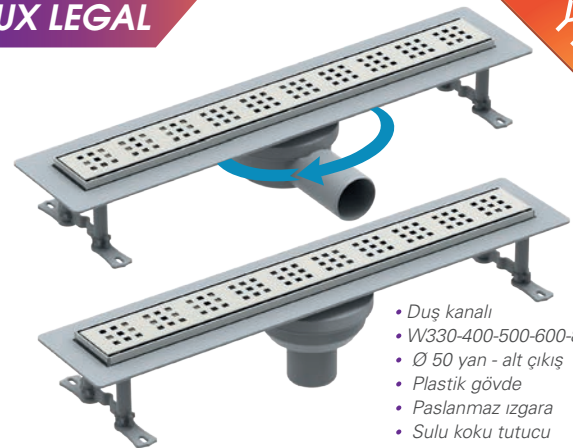

- Duş kanalı
- W330-400-500-600-800 mm
- Ø 50 yan - alt çıkış
- Plastik gövde
- Paslanmaz ızgara
- Sulu koku tutucu
- Yükseklik Ayarlı Çerçeve

YENİ!

LEGAL

Ürün Kodu	Kısa Kod	Çıkış	Ölçü	Fiyat
3159.0Y050K.033.1	26615	Ø 50	30 cm	149.00
3159.0Y050K.040.1	26616	Ø 50	40 cm	172.00
3159.0Y050K.050.1	26617	Ø 50	50 cm	196.00
3159.0Y050K.060.1	26618	Ø 50	60 cm	219.40
3159.0Y050K.080.1	26619	Ø 50	80 cm	264.00

Ürün Kodu	Kısa Kod	Çıkış	Ölçü	Fiyat
3159.0A050K.033.1	26610	Ø 50	30 cm	149.00
3159.0A050K.040.1	26611	Ø 50	40 cm	172.00
3159.0A050K.050.1	26612	Ø 50	50 cm	196.00
3159.0A050K.060.1	26613	Ø 50	60 cm	219.40
3159.0A050K.080.1	26614	Ø 50	80 cm	264.00



- Duş kanalı
- W200-330-400-500-600-800 mm
- Ø 50 yan - alt çıkış
- Plastik gövde
- Paslanmaz ızgara
- Sulu koku tutucu
- Yükseklik Ayarlı

LİNE T.M.

Ürün Kodu	Kısa Kod	Çıkış	Ölçü	Fiyat
3155.TY050K.033.1	26539	Ø 50	30 cm	152.40
3155.TY050K.040.1	26540	Ø 50	40 cm	178.00
3155.TY050K.050.1	26541	Ø 50	50 cm	205.80
3155.TY050K.060.1	26542	Ø 50	60 cm	231.70
3155.TY050K.080.1	26543	Ø 50	80 cm	278.70

Ürün Kodu	Kısa Kod	Çıkış	Ölçü	Fiyat
3155.TA050K.033.1	26534	Ø 50	30 cm	152.40
3155.TA050K.040.1	26535	Ø 50	40 cm	178.00
3155.TA050K.050.1	26536	Ø 50	50 cm	205.80
3155.TA050K.060.1	26537	Ø 50	60 cm	231.70
3155.TA050K.080.1	26538	Ø 50	80 cm	278.70



- Duş kanalı
- W200-330-400-500-600-800 mm
- Ø 50 yan - alt çıkış
- Plastik gövde
- Paslanmaz ızgara
- Sulu koku tutucu

LİNE T.M.

Ürün Kodu	Kısa Kod	Çıkış	Ölçü	Fiyat
3156.TY050K.033.1	26559	Ø 50	30 cm	157.40
3156.TY050K.040.1	26560	Ø 50	40 cm	183.40
3156.TY050K.050.1	26561	Ø 50	50 cm	216.40
3156.TY050K.060.1	26562	Ø 50	60 cm	242.00
3156.TY050K.080.1	26563	Ø 50	80 cm	289.20

Ürün Kodu	Kısa Kod	Çıkış	Ölçü	Fiyat
3156.TA050K.033.1	26554	Ø 50	30 cm	157.40
3156.TA050K.040.1	26555	Ø 50	40 cm	183.40
3156.TA050K.050.1	26556	Ø 50	50 cm	216.40
3156.TA050K.060.1	26557	Ø 50	60 cm	242.00
3156.TA050K.080.1	26558	Ø 50	80 cm	289.20



- Duş kanalı
- W200-330-400-500-600-800 mm
- Ø 50 yan - alt çıkış
- Plastik gövde
- Paslanmaz ızgara
- Sulu koku tutucu

ÜRÜN KODU KISA KOD ÇIKIŞ ÖLÇÜ FİYAT LİNE T.M.

3157.TY050K.033.1	26581	Ø 50	30 cm	12	157.40
3157.TY050K.040.1	26582	Ø 50	40 cm	12	183.40
3157.TY050K.050.1	26584	Ø 50	50 cm	12	216.40
3157.TY050K.060.1	26585	Ø 50	60 cm	12	242.00
3157.TY050K.080.1	26586	Ø 50	80 cm	12	289.20

3157.TA050K.033.1	26576	Ø 50	30 cm	12	157.40
3157.TA050K.040.1	26577	Ø 50	40 cm	12	183.40
3157.TA050K.050.1	26578	Ø 50	50 cm	12	216.40
3157.TA050K.060.1	26579	Ø 50	60 cm	12	242.00
3157.TA050K.080.1	26580	Ø 50	80 cm	12	289.20



- Duş kanalı
- W200-330-400-500-600-800 mm
- Ø 50 yan - alt çıkış
- Plastik gövde
- Paslanmaz seramik uyumlu ızgara
- Sulu koku tutucu

ÜRÜN KODU KISA KOD ÇIKIŞ ÖLÇÜ FİYAT LEGAL T.M.

3158.TY050K.033.1	26604	Ø 50	30 cm	12	162.00
3158.TY050K.040.1	26605	Ø 50	40 cm	12	190.00
3158.TY050K.050.1	26606	Ø 50	50 cm	12	217.00
3158.TY050K.060.1	26607	Ø 50	60 cm	12	244.00
3158.TY050K.080.1	26608	Ø 50	80 cm	12	292.00

3158.TA050K.033.1	26609	Ø 50	30 cm	12	162.00
3158.TA050K.040.1	26600	Ø 50	40 cm	12	190.00
3158.TA050K.050.1	26601	Ø 50	50 cm	12	217.00
3158.TA050K.060.1	26602	Ø 50	60 cm	12	244.00
3158.TA050K.080.1	26603	Ø 50	80 cm	12	292.00



- Duş kanalı
- W200-330-400-500-600-800 mm
- Ø 50 yan - alt çıkış
- Plastik gövde
- Paslanmaz ızgara
- Sulu koku tutucu
- Yükseklik ayarlı

ÜRÜN KODU KISA KOD ÇIKIŞ ÖLÇÜ FİYAT LEGAL T.M.

3159.TY050K.033.1	26625	Ø 50	30 cm	12	162.00
3159.TY050K.040.1	26626	Ø 50	40 cm	12	190.00
3159.TY050K.050.1	26627	Ø 50	50 cm	12	217.00
3159.TY050K.060.1	26628	Ø 50	60 cm	12	244.00
3159.TY050K.080.1	26629	Ø 50	80 cm	12	292.00

3159.TA050K.033.1	26620	Ø 50	30 cm	12	162.00
3159.TA050K.040.1	26621	Ø 50	40 cm	12	190.00
3159.TA050K.050.1	26622	Ø 50	50 cm	12	217.00
3159.TA050K.060.1	26623	Ø 50	60 cm	12	244.00
3159.TA050K.080.1	26624	Ø 50	80 cm	12	292.00



- Duş kanalı
- W200-330-400-500-600-800 mm
- Ø 50 yan - alt çıkış
- Plastik gövde
- Paslanmaz ızgara
- Sulu koku tutucu
- Yükseklik ayarlı

Ürün Kodu	Kısa Kod	Çıkış	Ölçü		Fiyat	LINE
-----------	----------	-------	------	---	-------	------

ALÇAK SEVİYELİ

4022.0Y050A.033.1	22310	Ø 50	33 cm	12	129.00
4022.0Y050A.040.1	22382	Ø 50	40 cm	12	139.00
4022.0Y050A.050.1	22391	Ø 50	50 cm	12	161.70
4022.0Y050A.060.1	22400	Ø 50	60 cm	12	186.70
4022.0Y050A.080.1	22409	Ø 50	80 cm	12	200.00

ALÇAK SEVİYELİ

4022.0A050A.033.1	22418	Ø 50	33 cm	12	129.00
4022.0A050A.040.1	22426	Ø 50	40 cm	12	139.00
4022.0A050A.050.1	22435	Ø 50	50 cm	12	161.70
4022.0A050A.060.1	22446	Ø 50	60 cm	12	186.70
4022.0A050A.080.1	22459	Ø 50	80 cm	12	200.00



- Duş kanalı
- W200-330-400-500-600-800 mm
- Ø 50 yan - alt çıkış
- Plastik gövde
- Paslanmaz ızgara
- Sulu koku tutucu

Ürün Kodu	Kısa Kod	Çıkış	Ölçü		Fiyat	LINE
-----------	----------	-------	------	---	-------	------

4022.0Y050K.033.1	16126	Ø 50	33 cm	12	129.00
4022.0Y050K.040.1	16138	Ø 50	40 cm	12	139.00
4022.0Y050K.050.1	16157	Ø 50	50 cm	12	161.70
4022.0Y050K.060.1	16168	Ø 50	60 cm	12	186.70
4022.0Y050K.080.1	16178	Ø 50	80 cm	12	200.00

4022.0A050K.033.1	16159	Ø 50	33 cm	12	129.00
4022.0A050K.040.1	16187	Ø 50	40 cm	12	139.00
4022.0A050K.050.1	16207	Ø 50	50 cm	12	161.70
4022.0A050K.060.1	16231	Ø 50	60 cm	12	186.70
4022.0A050K.080.1	16249	Ø 50	80 cm	12	200.00



- Duş kanalı
- W200-330-400-500-600-800 mm
- Ø 50 yan - alt çıkış
- Plastik gövde
- Paslanmaz ızgara
- Sulu koku tutucu

Ürün Kodu	Kısa Kod	Çıkış	Ölçü		Fiyat	LINE GOLD
-----------	----------	-------	------	---	-------	-----------

4022.0Y050G.033.1	16198	Ø 50	33 cm	12	186.70
4022.0Y050G.040.1	16217	Ø 50	40 cm	12	200.00
4022.0Y050G.050.1	16233	Ø 50	50 cm	12	233.40
4022.0Y050G.060.1	16252	Ø 50	60 cm	12	283.40
4022.0Y050G.080.1	16352	Ø 50	80 cm	12	303.40

4022.0A050G.033.1	16264	Ø 50	33 cm	12	186.70
4022.0A050G.040.1	16291	Ø 50	40 cm	12	200.00
4022.0A050G.050.1	16314	Ø 50	50 cm	12	233.40
4022.0A050G.060.1	16331	Ø 50	60 cm	12	283.40
4022.0A050G.080.1	16349	Ø 50	80 cm	12	303.40

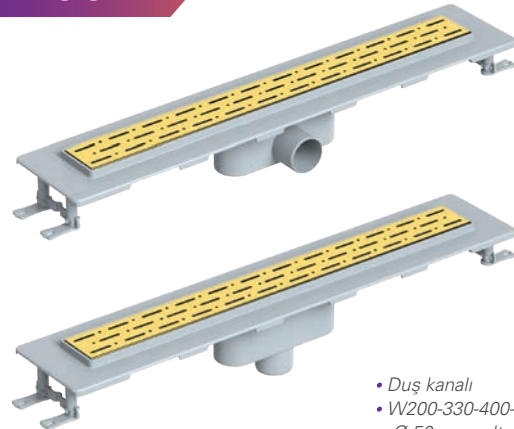

- Duş kanalı
- W200-330-400-500-600-800 mm
- Ø 50 yan - alt çıkış
- Plastik gövde
- Paslanmaz ızgara
- Sulu koku tutucu

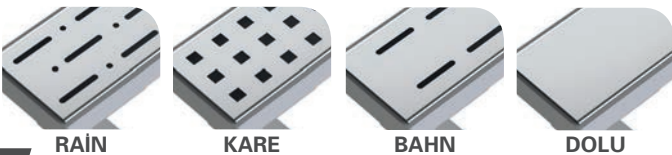

Ürün Kodu Kısa Kod Çıkış Ölçü Fiyat LINE T.M.

Ürün Kodu	Kısa Kod	Çıkış	Ölçü	Fiyat
4022.TY050K.033.1	16268	Ø 50	33 cm	139.40
4022.TY050K.040.1	16283	Ø 50	40 cm	149.50
4022.TY050K.050.1	16298	Ø 50	50 cm	171.40
4022.TY050K.060.1	16312	Ø 50	60 cm	200.00
4022.TY050K.080.1	16332	Ø 50	80 cm	220.00

Ürün Kodu	Kısa Kod	Çıkış	Ölçü	Fiyat
4022.TA050K.033.1	16363	Ø 50	33 cm	139.40
4022.TA050K.040.1	16395	Ø 50	40 cm	149.50
4022.TA050K.050.1	16413	Ø 50	50 cm	171.40
4022.TA050K.060.1	16436	Ø 50	60 cm	200.00
4022.TA050K.080.1	16451	Ø 50	80 cm	220.00



- Duş kanalı
- W200-330-400-500-600-800 mm
- Ø 50 yan - alt çıkış
- Plastik gövde
- Paslanmaz ızgara
- Tekstil membranlı
- Sulu koku tutucu

Ürün Kodu Kısa Kod Çıkış Ölçü Fiyat LINE T.M.GOLD

Ürün Kodu	Kısa Kod	Çıkış	Ölçü	Fiyat
4022.TY050G.033.1	16369	Ø 50	33 cm	200.00
4022.TY050G.040.1	16386	Ø 50	40 cm	213.40
4022.TY050G.050.1	16398	Ø 50	50 cm	233.40
4022.TY050G.060.1	16416	Ø 50	60 cm	283.40
4022.TY050G.080.1	16430	Ø 50	80 cm	310.00

Ürün Kodu	Kısa Kod	Çıkış	Ölçü	Fiyat
4022.TA050G.033.1	16446	Ø 50	33 cm	200.00
4022.TA050G.040.1	16469	Ø 50	40 cm	213.40
4022.TA050G.050.1	16495	Ø 50	50 cm	233.40
4022.TA050G.060.1	16516	Ø 50	60 cm	283.40
4022.TA050G.080.1	16543	Ø 50	80 cm	310.00

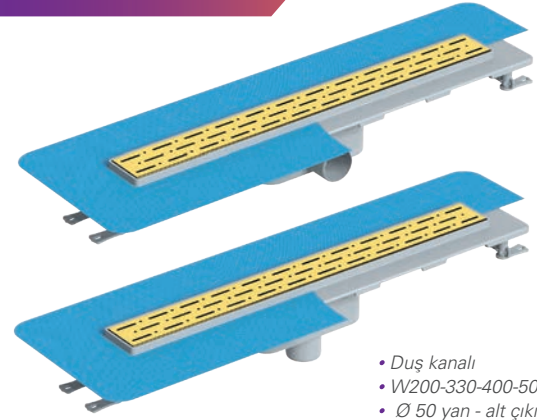

- Duş kanalı
- W200-330-400-500-600-800 mm
- Ø 50 yan - alt çıkış
- Plastik gövde
- Paslanmaz ızgara
- Tekstil membranlı
- Sulu koku tutucu

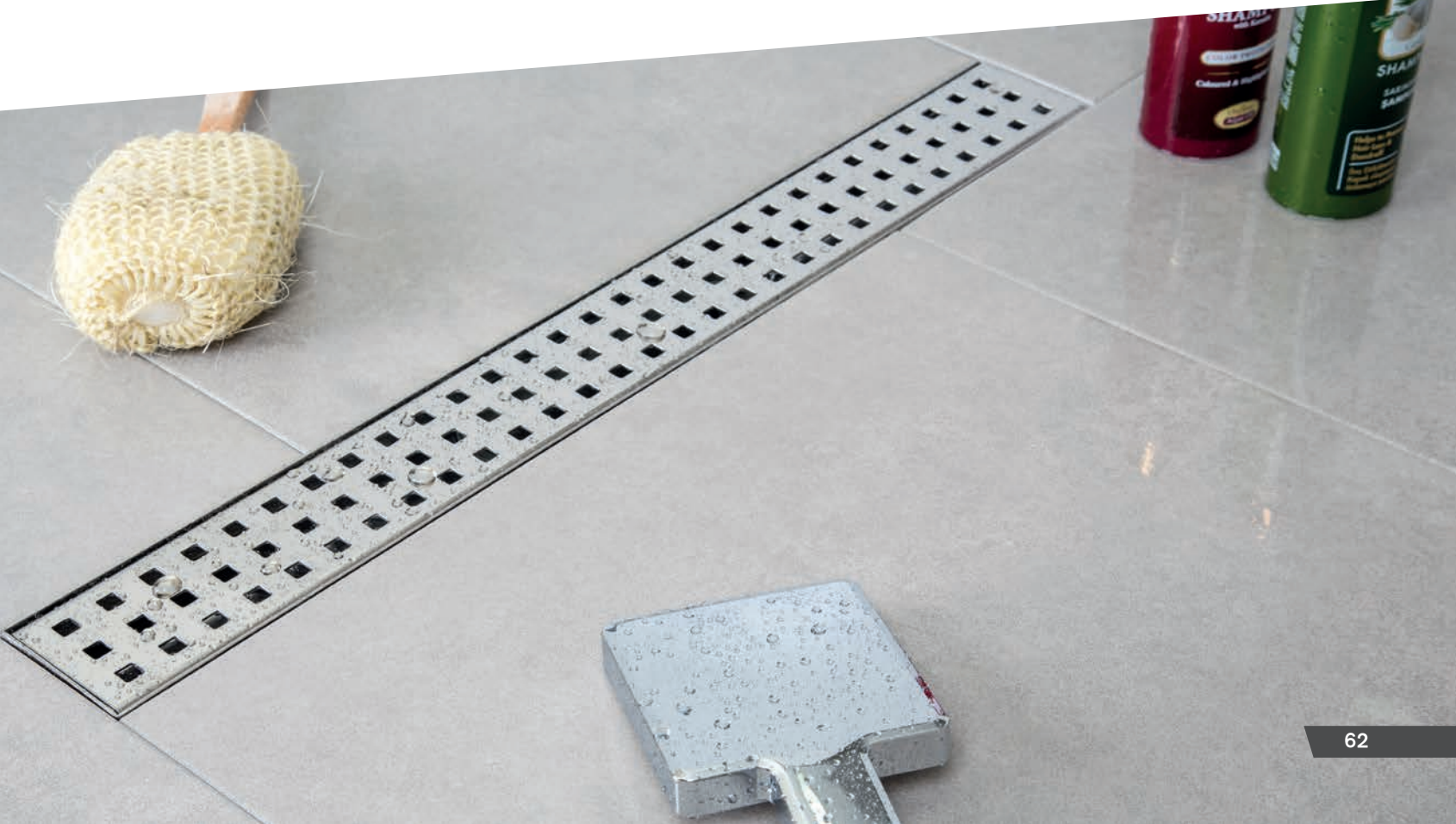

ÜRÜN KODU KISA KOD ÇIKIŞ ÖLÇÜ FİYAT DELUXE

4016.0Y050K.033.1	16462	Ø 50	33 cm	12	185.40
4016.0Y050K.040.1	16486	Ø 50	40 cm	12	196.70
4016.0Y050K.050.1	16497	Ø 50	50 cm	12	228.40
4016.0Y050K.060.1	16512	Ø 50	60 cm	12	257.50
4016.0Y050K.080.1	16527	Ø 50	80 cm	12	310.00

4016.0A050K.033.1	16542	Ø 50	33 cm	12	185.40
4016.0A050K.040.1	16570	Ø 50	40 cm	12	196.70
4016.0A050K.050.1	16592	Ø 50	50 cm	12	228.40
4016.0A050K.060.1	16608	Ø 50	60 cm	12	257.50
4016.0A050K.080.1	16625	Ø 50	80 cm	12	310.00



- Duş kanalı
- W200-330-400-500-600-800 mm
- Ø 50 yan - alt çıkış
- Plastik gövde
- Paslanmaz ızgara
- Sulu koku tutucu

ÜRÜN KODU KISA KOD ÇIKIŞ ÖLÇÜ FİYAT DELUXE T.M.

4016.TY050K.033.1	16555	Ø 50	33 cm	12	195.70
4016.TY050K.040.1	16572	Ø 50	40 cm	12	210.00
4016.TY050K.050.1	16587	Ø 50	50 cm	12	243.40
4016.TY050K.060.1	16604	Ø 50	60 cm	12	273.40
4016.TY050K.080.1	16634	Ø 50	80 cm	12	330.00

4016.TA050K.033.1	16643	Ø 50	33 cm	12	195.70
4016.TA050K.040.1	16666	Ø 50	40 cm	12	210.00
4016.TA050K.050.1	16683	Ø 50	50 cm	12	243.40
4016.TA050K.060.1	16704	Ø 50	60 cm	12	273.40
4016.TA050K.080.1	16722	Ø 50	80 cm	12	330.00

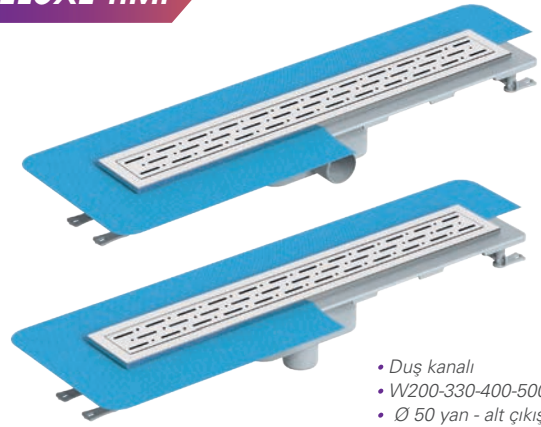

- Duş kanalı
- W200-330-400-500-600-800 mm
- Ø 50 yan - alt çıkış
- Plastik gövde
- Paslanmaz ızgara
- Tekstil membranlı
- Sulu koku tutucu

PARÇA NO	PARÇA AÇIKLAMASI	MALZEME	ADET
4016.1	Plastik Alt Gövde	ABS	1
4016.2	Koku Tutucu	ABS	1
4016.3	Paslanmaz Izgara	AISI 304	1
4016.4	Yükseklik Ayarlı Montaj Seti	PP	2

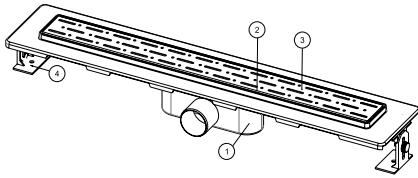

ÜRÜN KODU	W	L	H	Ø D	A	B	C	X	E	B1	A1
4016.0Y050K.033.1	423	134	72	49.5	360	88,9	11,35	385	1	56	325
4016.0Y050K.040.1	492	134	72	49.5	430	88,9	11,35	456	1	56	395
4016.0Y050K.050.1	592	134	72	49.5	530	88,9	11,35	556	1.5	56	495
4016.0Y050K.060.1	693	134	72	49.5	630	88,9	11,35	656	1.5	56	595
4016.0Y050K.080.1	893	134	72	49.5	830	88,9	11,35	856	1.5	56	795

ÜRÜN KODU	W	L	H	Ø D	A	B	C	X	E	B1	A1
4016.0A050K.033.1	423	134	100	49.5	360	88,9	11,35	385	1	56	325
4016.0A050K.040.1	492	134	100	49.5	430	88,9	11,35	456	1	56	395
4016.0A050K.050.1	592	134	100	49.5	530	88,9	11,35	556	1.5	56	495
4016.0A050K.060.1	693	134	100	49.5	630	88,9	11,35	656	1.5	56	595
4016.0A050K.080.1	893	134	100	49.5	830	88,9	11,35	856	1.5	56	795

Tablo ölçü birimi "mm"dir.

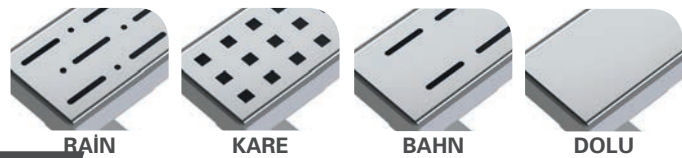

Detaylar

DN 50 Yan ve Alt çıkış – Pvc boru bağlantılarına uyumludur. Akış hızı 32 lt/dk'dır. Izgarası 304 kalite paslanmaz çeliktir.

Avantajlar

304 kalite paslanmaz çelik ızgarası sayesinde şık ve kaliteli bir görünüme sahiptir. Duvar dibi uygulamalarda rahatlıkla uygulanabilir. Su tutuculu koku önleyici sayesinde tesisattan gelecek kötü kokuları önler. Yükseltme ayakları sayesinde şapın yüksekliğine göre ayarlama olanağı sağlar.

Organik ve inorganik kimyasallara yüksek dayanım, çoğu asidik ve tuzlu su oksidasyonuna dayanıklıdır.

Kullanım Alanları

Genel kullanım banyo duşları, hastane ve otel duş alanları, soyunma odaları duş alanları vb.

Özel Üretim

Izgara modeli olarak isteğinize göre altın, bronz gibi renkler de üretilmektedir.

Uyarı

Yüksek yoğunluklu temizlik malzemelerinin uzun süreli kullanımı tavsiye edilmez.

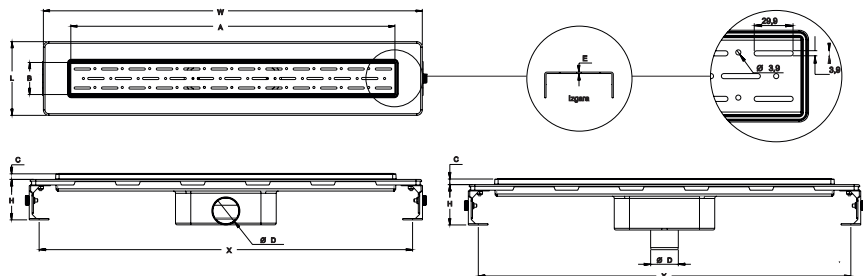

ÜRÜN KODU KISA KOD ÇIKIŞ ÖLÇÜ FİYAT LİNE

Ürün Kodu	Kısa Kod	Çıkış	Ölçü	Fiyat
4023.0Y050K.033.1	16648	Ø 50	33 cm	123.40
4023.0Y050K.040.1	16669	Ø 50	40 cm	135.40
4023.0Y050K.050.1	16689	Ø 50	50 cm	155.40
4023.0Y050K.060.1	16705	Ø 50	60 cm	184.70
4023.0Y050K.080.1	18687	Ø 50	80 cm	216.70



- Duş kanalı
- W200-330-400-500-600 mm
- Ø 50 yan - alt çıkış
- Plastik gövde
- Paslanmaz ızgara
- Sulu koku tutucu

ÜRÜN KODU KISA KOD ÇIKIŞ ÖLÇÜ FİYAT LİNE T.M.

Ürün Kodu	Kısa Kod	Çıkış	Ölçü	Fiyat
4023.TY050K.033.1	16739	Ø 50	33 cm	151.70
4023.TY050K.040.1	16768	Ø 50	40 cm	170.00
4023.TY050K.050.1	16783	Ø 50	50 cm	195.00
4023.TY050K.060.1	16800	Ø 50	60 cm	231.70
4023.TY050K.080.1	18739	Ø 50	80 cm	266.70



- Duş kanalı
- W200-330-400-500-600 mm
- Ø 50 yan - alt çıkış
- Plastik gövde
- Paslanmaz ızgara
- Tekstil membranlı
- Sulu koku tutucu

Ürün Kodu	Kısa Kod	Çıkış	Ölçü	Fiyat
4023.TA050K.033.1	16791	Ø 50	33 cm	151.70
4023.TA050K.040.1	16805	Ø 50	40 cm	170.00
4023.TA050K.050.1	16818	Ø 50	50 cm	195.00
4023.TA050K.060.1	16832	Ø 50	60 cm	231.70
4023.TA050K.080.1	18763	Ø 50	80 cm	266.70



ÜRÜN KODU **KISA KOD** **ÇIKIŞ** **ÖLÇÜ** **FİYAT** **LEGAL**

4024.0Y050K.033.1	16842	Ø 50	33 cm	12	156.70
4024.0Y050K.040.1	16857	Ø 50	40 cm	12	170.00
4024.0Y050K.050.1	16880	Ø 50	50 cm	12	193.40
4024.0Y050K.060.1	16902	Ø 50	60 cm	12	226.70
4024.0Y050K.080.1	18723	Ø 50	80 cm	12	263.40

4024.0A050K.033.1	16841	Ø 50	33 cm	12	156.70
4024.0A050K.040.1	16860	Ø 50	40 cm	12	170.00
4024.0A050K.050.1	16876	Ø 50	50 cm	12	193.40
4024.0A050K.060.1	16892	Ø 50	60 cm	12	226.70
4024.0A050K.080.1	18740	Ø 50	80 cm	12	263.40



- Duş kanalı
- W200-330-400-500-600 mm
- Ø 50 yan - alt çıkış
- Plastik gövde
- Paslanmaz ızgara
- Paslanmaz çita
- Sulu koku tutucu

ÜRÜN KODU **KISA KOD** **ÇIKIŞ** **ÖLÇÜ** **FİYAT** **LEGAL T.M.**

4024.TY050K.033.1	16922	Ø 50	33 cm	12	186.70
4024.TY050K.040.1	16940	Ø 50	40 cm	12	208.40
4024.TY050K.050.1	16951	Ø 50	50 cm	12	235.00
4024.TY050K.060.1	16968	Ø 50	60 cm	12	273.40
4024.TY050K.080.1	18754	Ø 50	80 cm	12	306.70

4024.TA050K.033.1	16915	Ø 50	33 cm	12	186.70
4024.TA050K.040.1	16941	Ø 50	40 cm	12	208.40
4024.TA050K.050.1	16967	Ø 50	50 cm	12	235.00
4024.TA050K.060.1	16986	Ø 50	60 cm	12	273.40
4024.TA050K.080.1	18770	Ø 50	80 cm	12	306.70



- Duş kanalı
- W200-330-400-500-600 mm
- Ø 50 yan - alt çıkış
- Plastik gövde
- Paslanmaz ızgara
- Paslanmaz çita
- Tekstil membranlı
- Sulu koku tutucu

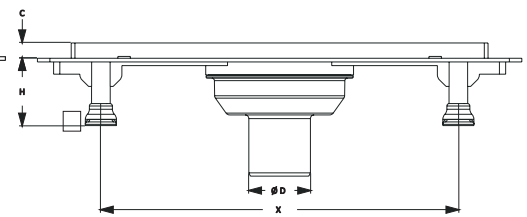
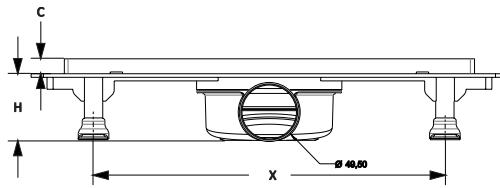
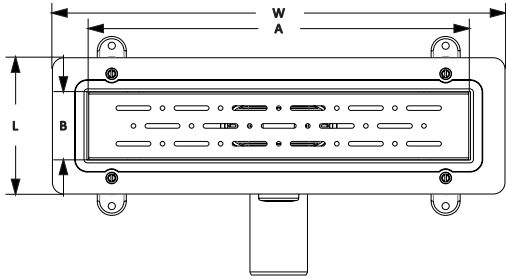

	W	L	H	Ø D	A	B	C	X	E
4024.0Y050K.033.1	389	119	55	50	335	64.5	12.5	287	1.2
4024.0Y050K.040.1	454	119	55	50	405	64.5	12.5	387	1.2
4024.0Y050K.050.1	554	119	55	50	505	64.5	12.5	487	1.2
4024.0Y050K.060.1	654	119	55	50	605	64.5	12.5	587	1.2

	W	L	H	Ø D	A	B	C	X	E
4024.0A050K.033.1	389	119	55	50	335	64.5	12.5	287	1.2
4024.0A050K.040.1	454	119	55	50	405	64.5	12.5	387	1.2
4024.0A050K.050.1	554	119	55	50	505	64.5	12.5	487	1.2
4024.0A050K.060.1	654	119	55	50	605	64.5	12.5	587	1.2

Tablo ölçü birimi "mm"dir.

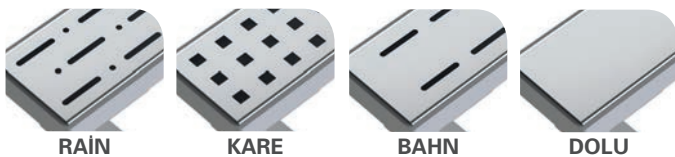

DELUXE

Ürün Kodu	Kısa Kod	Çıkış	Ölçü	İkili	Fiyat
4025.0Y050K.033.1	16978	Ø 50	33 cm	12	193.40
4025.0Y050K.040.1	17003	Ø 50	40 cm	12	208.40
4025.0Y050K.050.1	17031	Ø 50	50 cm	12	238.40
4025.0Y050K.060.1	17041	Ø 50	60 cm	12	268.40
4025.0Y050K.080.1	18784	Ø 50	80 cm	12	320.00

4025.0A050K.033.1	17004	Ø 50	33 cm	12	193.40
4025.0A050K.040.1	17018	Ø 50	40 cm	12	208.40
4025.0A050K.050.1	17030	Ø 50	50 cm	12	238.40
4025.0A050K.060.1	17071	Ø 50	60 cm	12	268.40
4025.0A050K.080.1	18795	Ø 50	80 cm	12	320.00



- Duş kanalı
- W200-330-400-500-600 mm
- Ø 50 yan - alt çıkış
- Plastik gövde
- Paslanmaz ızgara
- Paslanmaz çerçeve
- Sulu koku tutucu

DELUXE T.M.

Ürün Kodu	Kısa Kod	Çıkış	Ölçü	İkili	Fiyat
4025.TY050K.033.1	17050	Ø 50	33 cm	12	213.40
4025.TY050K.040.1	17059	Ø 50	40 cm	12	235.00
4025.TY050K.050.1	17081	Ø 50	50 cm	12	268.40
4025.TY050K.060.1	17098	Ø 50	60 cm	12	301.70
4025.TY050K.080.1	18792	Ø 50	80 cm	12	353.40

4025.TA050K.033.1	17085	Ø 50	33 cm	12	213.40
4025.TA050K.040.1	17130	Ø 50	40 cm	12	235.00
4025.TA050K.050.1	17145	Ø 50	50 cm	12	268.40
4025.TA050K.060.1	17160	Ø 50	60 cm	12	301.70
4025.TA050K.080.1	18815	Ø 50	80 cm	12	353.40

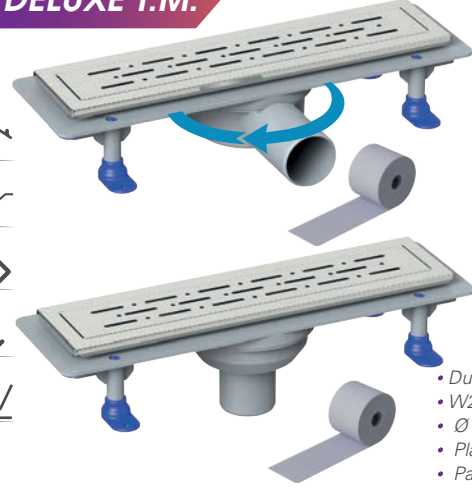

- Duş kanalı
- W200-330-400-500-600 mm
- Ø 50 yan - alt çıkış
- Plastik gövde
- Paslanmaz ızgara
- Paslanmaz çerçeve
- Tekstil membranlı
- Sulu koku tutucu



Ürün Kodu

Kısa Kod Çıkış

Ölçü



Fiyat

SCALA

4026.0Y050K.033.1	17107	Ø 50	33 cm	12	123.40
4026.0Y050K.040.1	17108	Ø 50	40 cm	12	136.70
4026.0Y050K.050.1	17109	Ø 50	50 cm	12	155.00
4026.0Y050K.060.1	17110	Ø 50	60 cm	12	170.00
4026.0Y050K.080.1	18806	Ø 50	80 cm	12	218.40



- Duş kanalı
- W200-330-400-500-600 mm
- Ø 50 yan - alt çıkış
- Plastik gövde
- Paslanmaz seramik uyumlu çerçeve

Ürün Kodu

Kısa Kod Çıkış

Ölçü



Fiyat

SCALA T.M.

4026.TY050K.033.1	17115	Ø 50	33 cm	12	146.70
4026.TY050K.040.1	17116	Ø 50	40 cm	12	165.00
4026.TY050K.050.1	17117	Ø 50	50 cm	12	188.40
4026.TY050K.060.1	17118	Ø 50	60 cm	12	208.40
4026.TY050K.080.1	18813	Ø 50	80 cm	12	260.00

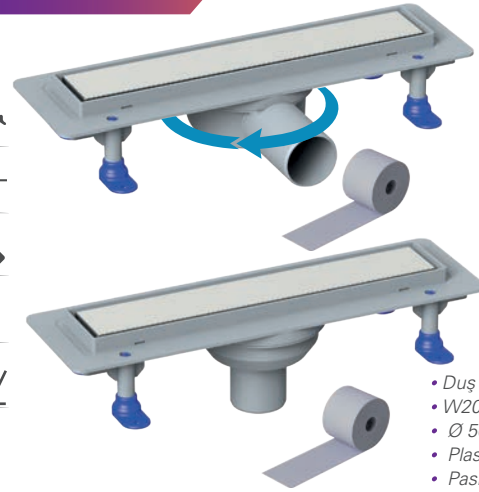

- Duş kanalı
- W200-330-400-500-600 mm
- Ø 50 yan - alt çıkış
- Plastik gövde
- Paslanmaz seramik uyumlu çerçeve
- Tekstil membranlı

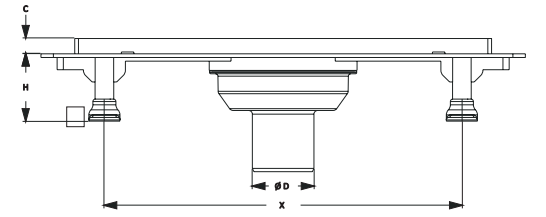
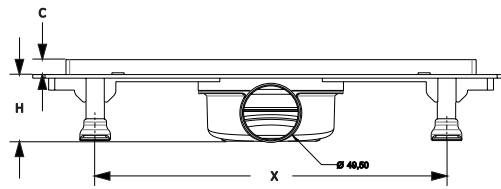
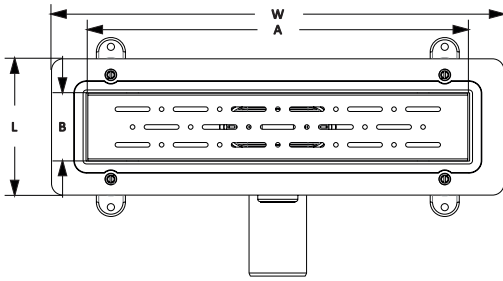

	W	L	H	Ø D	A	B	C	X	E
4024.0Y050K.033.1	389	119	55	50	335	64.5	12.5	287	1.2
4024.0Y050K.040.1	454	119	55	50	405	64.5	12.5	387	1.2
4024.0Y050K.050.1	554	119	55	50	505	64.5	12.5	487	1.2
4024.0Y050K.060.1	654	119	55	50	605	64.5	12.5	587	1.2

	W	L	H	Ø D	A	B	C	X	E
4024.0A050K.033.1	389	119	55	50	335	64.5	12.5	287	1.2
4024.0A050K.040.1	454	119	55	50	405	64.5	12.5	387	1.2
4024.0A050K.050.1	554	119	55	50	505	64.5	12.5	487	1.2
4024.0A050K.060.1	654	119	55	50	605	64.5	12.5	587	1.2

Tablo ölçü birimi "mm"dir.

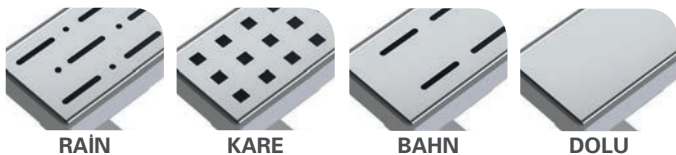

Ürünlerimiz



göre üretilmiştir.

Ürün Kodu

Kısa Kod

Çıkış

Ölçü



Fiyat

SCALA LEGAL

4027.0Y050K.033.1	17128	Ø 50	33 cm	12	161.70
4027.0Y050K.040.1	17131	Ø 50	40 cm	12	175.00
4027.0Y050K.050.1	17133	Ø 50	50 cm	12	195.00
4027.0Y050K.060.1	17135	Ø 50	60 cm	12	211.70
4027.0Y050K.080.1	18818	Ø 50	80 cm	12	260.00



- Duş kanalı
- W200-330-400-500-600 mm
- Ø 50 yan - alt çıkış
- Plastik gövde
- Paslanmaz seramik uyumlu çerçeve ve çita

Ürün Kodu

Kısa Kod

Çıkış

Ölçü



Fiyat

SCALA LEGAL T.M.

4027.TY050K.033.1	17148	Ø 50	33 cm	12	175.00
4027.TY050K.040.1	17151	Ø 50	40 cm	12	193.40
4027.TY050K.050.1	17153	Ø 50	50 cm	12	218.40
4027.TY050K.060.1	17156	Ø 50	60 cm	12	238.40
4027.TY050K.080.1	18824	Ø 50	80 cm	12	291.70



- Duş kanalı
- W200-330-400-500-600 mm
- Ø 50 yan - alt çıkış
- Plastik gövde
- Paslanmaz seramik uyumlu çerçeve ve çita
- Tekstil membranlı

Ürün Kodu

Kısa Kod

Çıkış

Ölçü



Fiyat

4027.TA050K.033.1	17159	Ø 50	33 cm	12	175.00
4027.TA050K.040.1	17161	Ø 50	40 cm	12	193.40
4027.TA050K.050.1	17163	Ø 50	50 cm	12	218.40
4027.TA050K.060.1	17165	Ø 50	60 cm	12	238.40
4027.TA050K.080.1	18828	Ø 50	80 cm	12	291.70



ÜRÜN KODU KISA KOD ÇIKIŞ ÖLÇÜ FİYAT SCALA DELUXE

Ürün Kodu	Kısa Kod	Çıkış	Ölçü	Fiyat
4028.0Y050K.033.1	17173	Ø 50	33 cm	120.00
4028.0Y050K.040.1	17176	Ø 50	40 cm	205.00
4028.0Y050K.050.1	17177	Ø 50	50 cm	233.40
4028.0Y050K.060.1	17178	Ø 50	60 cm	260.00
4028.0Y050K.080.1	18830	Ø 50	80 cm	320.00



- Duş kanalı
- W200-330-400-500-600 mm
- Ø 50 yan - alt çıkış
- Plastik gövde
- Paslanmaz seramik uyumlu ızgara
- Paslanmaz dış çerçeve

ÜRÜN KODU KISA KOD ÇIKIŞ ÖLÇÜ FİYAT SCALA DELUXE T.M.

Ürün Kodu	Kısa Kod	Çıkış	Ölçü	Fiyat
4028.TY050K.033.1	17181	Ø 50	33 cm	210.00
4028.TY050K.040.1	17182	Ø 50	40 cm	230.00
4028.TY050K.050.1	17183	Ø 50	50 cm	260.00
4028.TY050K.060.1	17184	Ø 50	60 cm	290.00
4028.TY050K.080.1	18832	Ø 50	80 cm	360.00

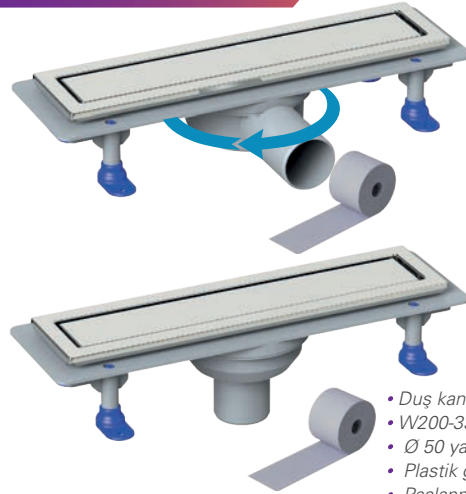

- Duş kanalı
- W200-330-400-500-600 mm
- Ø 50 yan - alt çıkış
- Plastik gövde
- Paslanmaz seramik uyumlu ızgara
- Paslanmaz dış çerçeve
- Tekstil membranlı

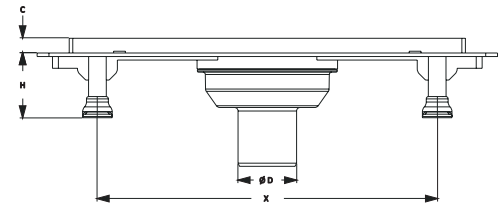
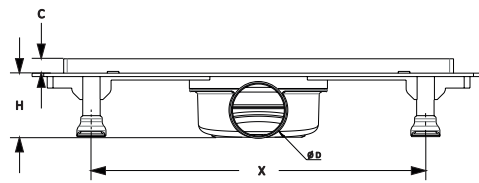
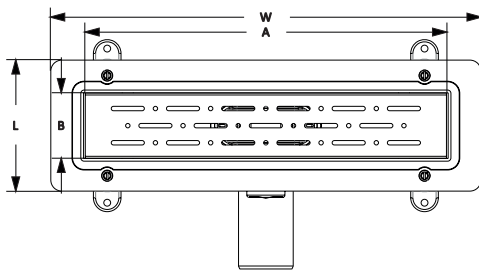

Detaylar

DN 50 Yan ve Alt çıkış – Pvc boru bağlantılarına uyumludur. Akış hızı 32 lt/dk'dır. Izgarası 304 kalite paslanmaz çeliktir.

Avantajlar

304 kalite paslanmaz çelik ızgarası sayesinde şık ve kaliteli bir görünüme sahiptir. Duvar dibi uygulamalarda rahatlıkla uygulanabilir. Su tutuculu koku önleyici sayesinde tesisattan gelecek kötü kokuları önler. Yükseltme ayakları sayesinde şapın yüksekliğine göre ayarlama olanağı sağlar.

Organik ve inorganik kimyasallara yüksek dayanım, çoğu asidik ve tuzlu su oksidasyonuna dayanıklıdır.

Kullanım Alanları

Genel kullanım banyo duşları, hastane ve otel duş alanları, soyunma odaları duş alanları vb.

Özel Üretim

Izgara modeli olarak isteğinize göre altın, bronz gibi renkler de üretilmektedir.

Uyarı

Yüksek yoğunluklu temizlik malzemelerinin uzun süreli kullanımı tavsiye edilmez.

	W	L	H	ØD	A	B	C	X	E
4028.0Y050K.033.1	389	119	55	50	335	64.5	12.5	287	1.2
4028.0Y050K.040.1	454	119	55	50	405	64.5	12.5	387	1.2
4028.0Y050K.050.1	554	119	55	50	505	64.5	12.5	487	1.2
4028.0Y050K.060.1	654	119	55	50	605	64.5	12.5	587	1.2

	W	L	H	ØD	A	B	C	X	E
4028.0A050K.033.1	389	119	55	50	335	64.5	12.5	287	1.2
4028.0A050K.040.1	454	119	55	50	405	64.5	12.5	387	1.2
4028.0A050K.050.1	554	119	55	50	505	64.5	12.5	487	1.2
4028.0A050K.060.1	654	119	55	50	605	64.5	12.5	587	1.2

Tablo ölçü birimi "mm"dir.

ÜRÜN KODU KISA KOD ÇIKIŞ ÖLÇÜ FİYAT LINE

Ürün Kodu	Kısa Kod	Çıkış	Ölçü	Fiyat
4033.0Y050K.033.1	17186	Ø 50	33 cm	12 194.20
4033.0Y050K.040.1	17203	Ø 50	40 cm	12 211.70
4033.0Y050K.050.1	17216	Ø 50	50 cm	12 245.80
4033.0Y050K.060.1	17236	Ø 50	60 cm	12 275.40
4033.0Y050K.080.1	17249	Ø 50	80 cm	12 332.00

Ürün Kodu	Kısa Kod	Çıkış	Ölçü	Fiyat
4033.0A050K.033.1	17189	Ø 50	33 cm	12 194.20
4033.0A050K.040.1	17214	Ø 50	40 cm	12 211.70
4033.0A050K.050.1	17233	Ø 50	50 cm	12 245.80
4033.0A050K.060.1	17261	Ø 50	60 cm	12 275.40
4033.0A050K.080.1	17282	Ø 50	80 cm	12 332.00



- Duş kanalı
- W200-330-400-500-600-800 mm
- Ø 50 yan - alt çıkış
- Plastik gövde
- Yükseklik ayarlı paslanmaz çerçeve
- Paslanmaz ızgara
- Sulu koku tutucu

ÜRÜN KODU KISA KOD ÇIKIŞ ÖLÇÜ FİYAT LINE GOLD

Ürün Kodu	Kısa Kod	Çıkış	Ölçü	Fiyat
4033.0Y050G.033.1	17258	Ø 50	33 cm	12 278.00
4033.0Y050G.040.1	17278	Ø 50	40 cm	12 309.00
4033.0Y050G.050.1	17297	Ø 50	50 cm	12 364.00
4033.0Y050G.060.1	17314	Ø 50	60 cm	12 430.40
4033.0Y050G.080.1	17333	Ø 50	80 cm	12 510.40

Ürün Kodu	Kısa Kod	Çıkış	Ölçü	Fiyat
4033.0A050G.033.1	17294	Ø 50	33 cm	12 278.00
4033.0A050G.040.1	17315	Ø 50	40 cm	12 309.00
4033.0A050G.050.1	17343	Ø 50	50 cm	12 364.00
4033.0A050G.060.1	17354	Ø 50	60 cm	12 430.40
4033.0A050G.080.1	17374	Ø 50	80 cm	12 510.40



- Duş kanalı
- W200-330-400-500-600-800 mm
- Ø 50 yan - alt çıkış
- Plastik gövde
- Yükseklik ayarlı paslanmaz çerçeve
- Paslanmaz ızgara
- Sulu koku tutucu

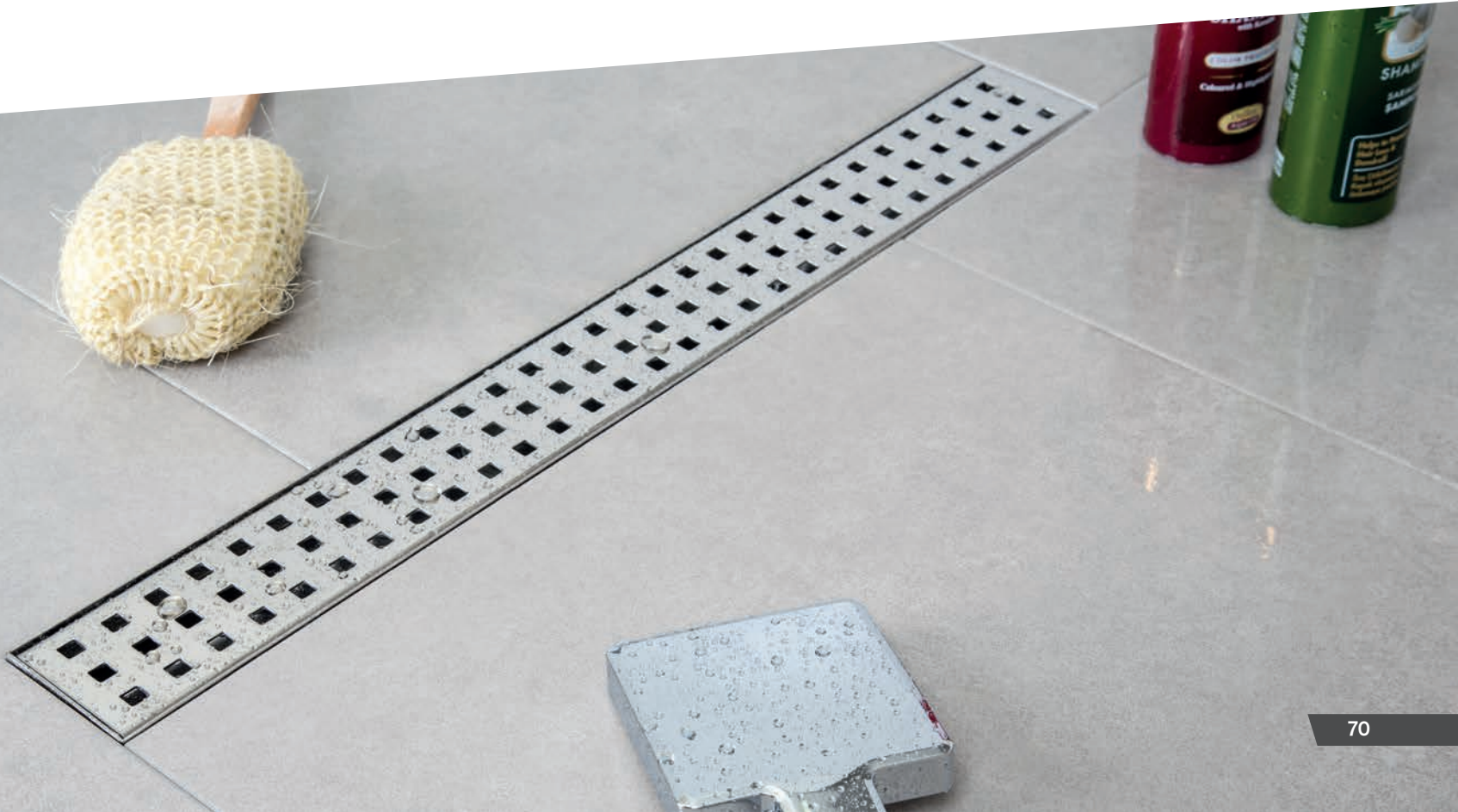

ÜRÜN KODU KISA KOD ÇIKIŞ ÖLÇÜ FİYAT LINE T.M.

4033.TY050K.033.1	17358	Ø 50	33 cm	12	200.70
4033.TY050K.040.1	17372	Ø 50	40 cm	12	220.00
4033.TY050K.050.1	17398	Ø 50	50 cm	12	255.50
4033.TY050K.060.1	17410	Ø 50	60 cm	12	284.00
4033.TY050K.080.1	17434	Ø 50	80 cm	12	345.00

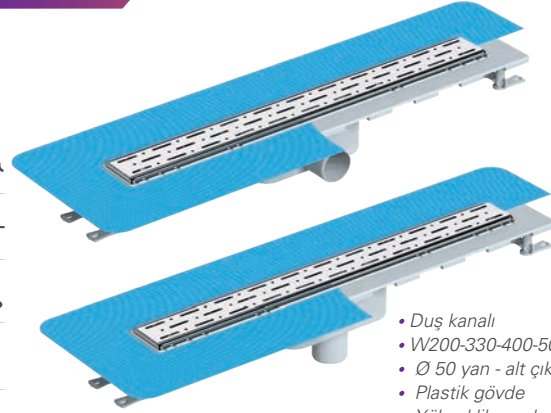

- Duş kanalı
- W200-330-400-500-600-800 mm
- Ø 50 yan - alt çıkış
- Plastik gövde
- Yükseklik ayarlı paslanmaz çerçeve
- Paslanmaz ızgara
- Tekstil membranlı
- Sulu koku tutucu

ÜRÜN KODU KISA KOD ÇIKIŞ ÖLÇÜ FİYAT LINE T.M.GOLD

4033.TY050G.033.1	17448	Ø 50	33 cm	12	326.70
4033.TY050G.040.1	17464	Ø 50	40 cm	12	363.40
4033.TY050G.050.1	17477	Ø 50	50 cm	12	426.70
4033.TY050G.060.1	17492	Ø 50	60 cm	12	466.70
4033.TY050G.080.1	17506	Ø 50	80 cm	12	553.90

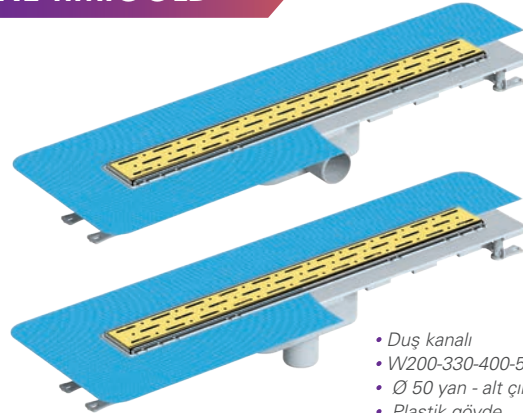

- Duş kanalı
- W200-330-400-500-600-800 mm
- Ø 50 yan - alt çıkış
- Plastik gövde
- Yükseklik ayarlı paslanmaz çerçeve
- Paslanmaz ızgara
- Tekstil membranlı
- Sulu koku tutucu

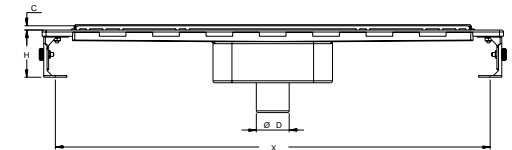
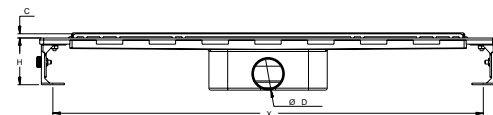
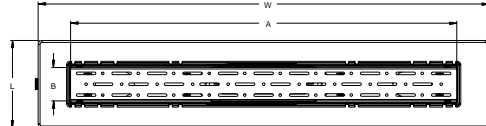

ÜRÜN KODU	W	L	H	ØD	A	B	C	X	E
4033.TY050K.033.1	423	134	72	49.5	330	54	8	385	1.5
4033.TY050K.040.1	492	134	72	49.5	400	54	8	456	1.5
4033.TY050K.050.1	592	134	72	49.5	500	54	8	556	1.5
4033.TY050K.060.1	693	134	72	49.5	600	54	8	656	1.5
4033.TY050K.080.1	893	134	72	49.5	800	54	8	856	1.5

PARÇA NO	PARÇA AÇIKLAMASI	MALZEME	ADET
4033.1	Plastik Gövde Etekli	ABS	1
4033.2	Yükseklik Ayarlı Montaj Seti	PP	2
4033.3	Koku Tutucu	ABS	1
4033.4	Yük. Ayarlı Çerçeve	AISI 304	1
4033.5	Paslanmaz Izgara	AISI 304	1

ÜRÜN KODU	W	L	H	ØD	A	B	C	X	E
4033.TA050K.033.1	423	134	100	49.5	330	54	8	385	1.5
4033.TA050K.040.1	492	134	100	49.5	400	54	8	456	1.5
4033.TA050K.050.1	592	134	100	49.5	500	54	8	556	1.5
4033.TA050K.060.1	693	134	100	49.5	600	54	8	656	1.5
4033.TA050K.080.1	893	134	100	49.5	800	54	8	856	1.5

Tablo ölçü birimi "mm"dir.

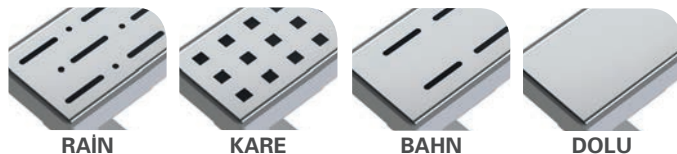
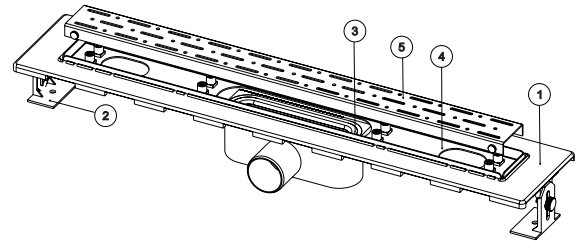

Ürünlerimiz  göre üretilmiştir.

LEGAL

Ürün Kodu	Kısa Kod	Çıkış	Ölçü	Fiyat
4043.0Y050K.033.1	17524	Ø 50	33 cm	350.00
4043.0Y050K.040.1	17538	Ø 50	40 cm	383.40
4043.0Y050K.050.1	17557	Ø 50	50 cm	433.40
4043.0Y050K.060.1	17575	Ø 50	60 cm	493.40
4043.0Y050K.080.1	18834	Ø 50	80 cm	566.70

Ürün Kodu	Kısa Kod	Çıkış	Ölçü	Fiyat
4043.0A050K.033.1	17601	Ø 50	33 cm	350.00
4043.0A050K.040.1	17619	Ø 50	40 cm	383.40
4043.0A050K.050.1	17640	Ø 50	50 cm	433.40
4043.0A050K.060.1	17661	Ø 50	60 cm	493.40
4043.0A050K.080.1	18994	Ø 50	80 cm	566.70



- Duş kanalı
- Ø 50 yan - alt çıkış
- Paslanmaz gövde
- Yükseklik ayarlı paslanmaz çerçeve
- Yükseklik ayarlı paslanmaz ızgara
- Sulu koku tutucu

LEGAL GOLD

Ürün Kodu	Kısa Kod	Çıkış	Ölçü	Fiyat
4043.0Y050G.033.1	17604	Ø 50	33 cm	366.70
4043.0Y050G.040.1	17623	Ø 50	40 cm	406.70
4043.0Y050G.050.1	17639	Ø 50	50 cm	466.70
4043.0Y050G.060.1	17656	Ø 50	60 cm	520.00
4043.0Y050G.080.1	17673	Ø 50	80 cm	620.00

Ürün Kodu	Kısa Kod	Çıkış	Ölçü	Fiyat
4043.0A050G.033.1	17688	Ø 50	33 cm	366.70
4043.0A050G.040.1	17703	Ø 50	40 cm	406.70
4043.0A050G.050.1	17712	Ø 50	50 cm	466.70
4043.0A050G.060.1	17734	Ø 50	60 cm	520.00
4043.0A050G.080.1	17751	Ø 50	80 cm	620.00



- Duş kanalı
- Ø 50 yan - alt çıkış
- Paslanmaz gövde
- Yükseklik ayarlı paslanmaz çerçeve
- Yükseklik ayarlı paslanmaz ızgara
- Sulu koku tutucu

ÜRÜN KODU KISA KOD ÇIKIŞ ÖLÇÜ FİYAT LEGAL T.M.

4043.TY050K.033.1	17717	Ø 50	33 cm	12	366.70
4043.TY050K.040.1	17732	Ø 50	40 cm	12	406.70
4043.TY050K.050.1	17750	Ø 50	50 cm	12	460.00
4043.TY050K.060.1	17767	Ø 50	60 cm	12	506.70
4043.TY050K.080.1	17783	Ø 50	80 cm	12	603.40

4043.TA050K.033.1	17771	Ø 50	33 cm	12	366.70
4043.TA050K.040.1	17789	Ø 50	40 cm	12	406.70
4043.TA050K.050.1	17801	Ø 50	50 cm	12	460.00
4043.TA050K.060.1	17810	Ø 50	60 cm	12	506.70
4043.TA050K.080.1	17823	Ø 50	80 cm	12	603.40

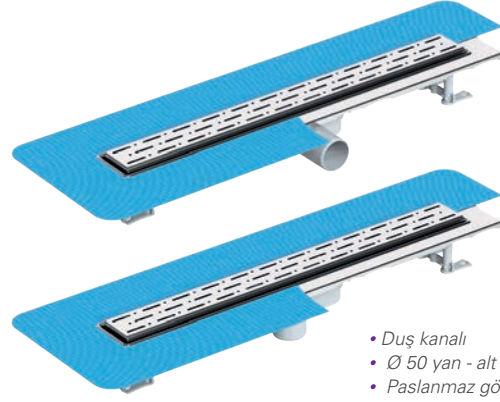

- Duş kanalı
- Ø 50 yan - alt çıkış
- Paslanmaz gövde
- Yükseklik ayarlı paslanmaz çerçeve
- Yükseklik ayarlı paslanmaz ızgara
- Tekstil membranlı
- Sulu koku tutucu

ÜRÜN KODU KISA KOD ÇIKIŞ ÖLÇÜ FİYAT LEGAL T.M.GOLD

4043.TY050G.033.1	17819	Ø 50	33 cm	12	390.00
4043.TY050G.040.1	17859	Ø 50	40 cm	12	436.70
4043.TY050G.050.1	17889	Ø 50	50 cm	12	496.70
4043.TY050G.060.1	17902	Ø 50	60 cm	12	550.00
4043.TY050G.080.1	17911	Ø 50	80 cm	12	660.00

4043.TA050G.033.1	17832	Ø 50	33 cm	12	390.00
4043.TA050G.040.1	17845	Ø 50	40 cm	12	436.70
4043.TA050G.050.1	17856	Ø 50	50 cm	12	496.70
4043.TA050G.060.1	17868	Ø 50	60 cm	12	550.00
4043.TA050G.080.1	17880	Ø 50	80 cm	12	660.00

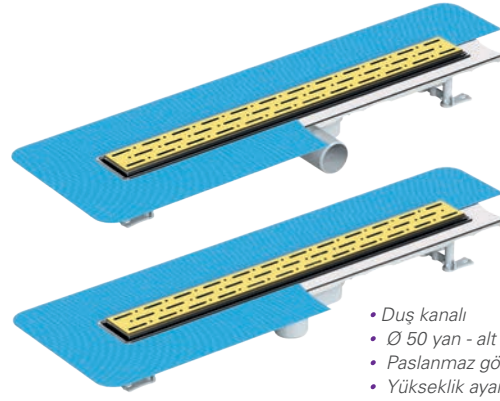

- Duş kanalı
- Ø 50 yan - alt çıkış
- Paslanmaz gövde
- Yükseklik ayarlı paslanmaz çerçeve
- Yükseklik ayarlı paslanmaz ızgara
- Tekstil membranlı
- Sulu koku tutucu

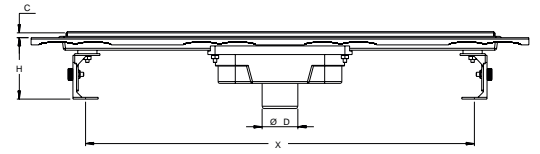
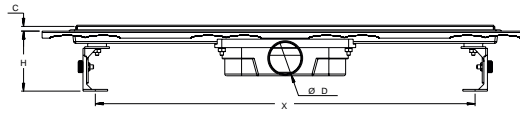
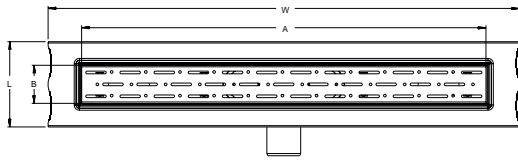

ÜRÜN KODU	W	L	H	ØD	A	B	C	X	E
4043.TY050K.033.1	423	134	85	49.5	330	54	8	385	1.5
4043.TY050K.040.1	492	134	85	49.5	400	54	8	456	1.5
4043.TY050K.050.1	592	134	85	49.5	500	54	8	556	1.5
4043.TY050K.060.1	693	134	85	49.5	600	54	8	656	1.5
4043.TY050K.080.1	893	134	85	49.5	800	54	8	856	1.5

ÜRÜN KODU	W	L	H	ØD	A	B	C	X	E
4043.TA050K.033.1	423	134	100	49.5	330	54	8	385	1.5
4043.TA050K.040.1	492	134	100	49.5	400	54	8	456	1.5
4043.TA050K.050.1	592	134	100	49.5	500	54	8	556	1.5
4043.TA050K.060.1	693	134	100	49.5	600	54	8	656	1.5
4043.TA050K.080.1	893	134	100	49.5	800	54	8	856	1.5

Tablo ölçü birimi "mm"dir.

PARÇA NO	PARÇA AÇIKLAMASI	MALZEME	ADET
4043.1	Plastik Alt Gövde	ABS	1
4043.2	Paslanmaz Üst Gövde	AISI 304	1
4043.3	Yükseklik Ayarlı Montaj Seti	PP	2
4043.4	Yükseklik Ayarlı Çerçeve	AISI 304	1
4043.5	Paslanmaz Izgara	AISI 304	1
4043.6	Koku Tutucu	ABS	1

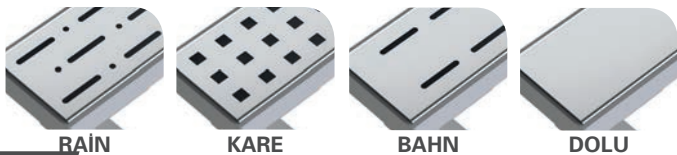
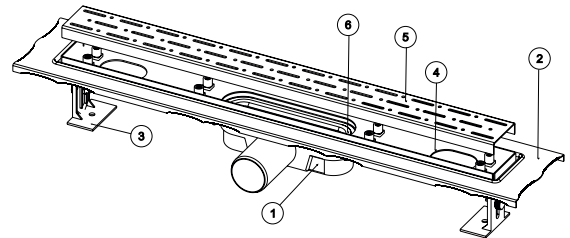

Ürünlerimiz göre üretilmiştir.

ÜRÜN KODU

KISA KOD

ÇIKIŞ

ÖLÇÜ



FİYAT

LEGAL 360°

4043.00360K.033.1	17920	Ø 50	33 cm	12	350.00
4043.00360K.040.1	17929	Ø 50	40 cm	12	383.40
4043.00360K.050.1	17938	Ø 50	50 cm	12	463.40
4043.00360K.060.1	17947	Ø 50	60 cm	12	496.70
4043.00360K.080.1	17956	Ø 50	80 cm	12	586.70



- Duş kanalı
- Ø 50 yan çıkış
- Paslanmaz gövde
- Yükseklik ayarlı paslanmaz çerçeve
- Paslanmaz ızgara
- Sulu koku tutucu

ÜRÜN KODU

KISA KOD

ÇIKIŞ

ÖLÇÜ



FİYAT

LEGAL 360° TM

4043.T0360K.033.1	27235	Ø 50	33 cm	12	390.00
4043.T0360K.040.1	27236	Ø 50	40 cm	12	460.00
4043.T0360K.050.1	27237	Ø 50	50 cm	12	506.70
4043.T0360K.060.1	27230	Ø 50	60 cm	12	540.00
4043.T0360K.080.1	27238	Ø 50	80 cm	12	626.70



- Duş kanalı
- Ø 50 yan çıkış
- Paslanmaz gövde
- Yükseklik ayarlı paslanmaz çerçeve
- Paslanmaz ızgara
- Sulu koku tutucu

ÜRÜN KODU

KISA KOD

ÇIKIŞ

ÖLÇÜ



FİYAT

LEGAL Y360°

4043.0Y360K.033.1	18012	Ø 50	33 cm	12	396.70
4043.0Y360K.040.1	18021	Ø 50	40 cm	12	436.70
4043.0Y360K.050.1	18030	Ø 50	50 cm	12	520.00
4043.0Y360K.060.1	18039	Ø 50	60 cm	12	550.00
4043.0Y360K.080.1	18048	Ø 50	80 cm	12	633.40

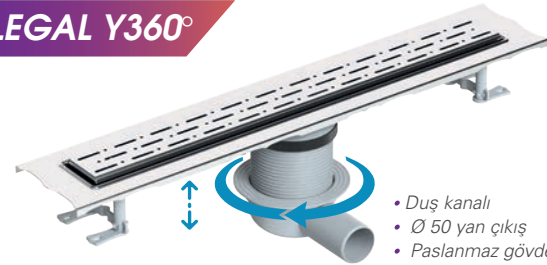

- Duş kanalı
- Ø 50 yan çıkış
- Paslanmaz gövde
- Yükseklik ayarlı paslanmaz çerçeve
- Paslanmaz ızgara
- Sulu koku tutucu

ÜRÜN KODU

KISA KOD

ÇIKIŞ

ÖLÇÜ



FİYAT

LEGAL 360° GOLD

4043.00360G.033.1	17966	Ø 50	20 cm	12	393.40
4043.00360G.040.1	17976	Ø 50	33 cm	12	423.40
4043.00360G.050.1	17985	Ø 50	40 cm	12	516.70
4043.00360G.060.1	17994	Ø 50	50 cm	12	553.40
4043.00360G.080.1	18003	Ø 50	60 cm	12	653.40

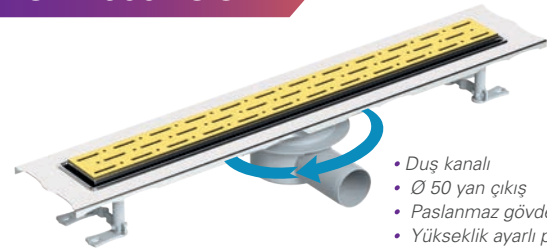

- Duş kanalı
- Ø 50 yan çıkış
- Paslanmaz gövde
- Yükseklik ayarlı paslanmaz çerçeve
- Paslanmaz ızgara
- Sulu koku tutucu

ÜRÜN KODU

KISA KOD

ÇIKIŞ

ÖLÇÜ



FİYAT

LEGAL Y360° GOLD

4043.0Y360G.033.1	18058	Ø 50	33 cm	12	423.40
4043.0Y360G.040.1	18073	Ø 50	40 cm	12	473.40
4043.0Y360G.050.1	18090	Ø 50	50 cm	12	563.40
4043.0Y360G.060.1	18106	Ø 50	60 cm	12	636.70
4043.0Y360G.080.1	18122	Ø 50	80 cm	12	683.40

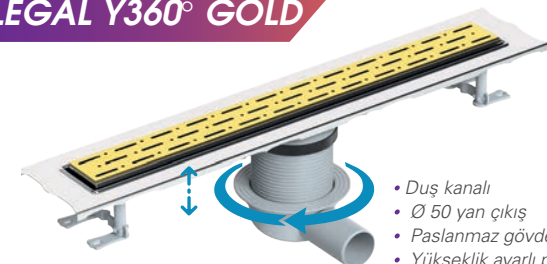

- Duş kanalı
- Ø 50 yan çıkış
- Paslanmaz gövde
- Yükseklik ayarlı paslanmaz çerçeve
- Paslanmaz ızgara
- Sulu koku tutucu

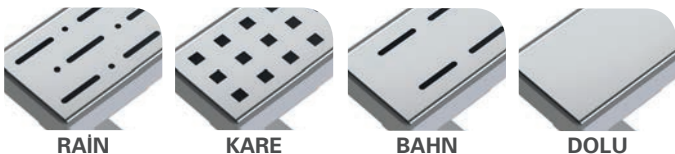

RAIN

KARE

BAHN

DOLU

Ürünlerimiz  göre üretilmiştir.

ÜRÜN KODU KISA KOD ÇIKIŞ ÖLÇÜ FİYAT PREMIUM

Ürün Kodu	Kısa Kod	Çıkış	Ölçü	Fiyat
4045.0Y050K.033.9	18059	Ø 50	33 cm	596.70
4045.0Y050K.045.9	18062	Ø 50	45 cm	683.40
4045.0Y050K.060.9	18065	Ø 50	60 cm	850.00
4045.0Y050K.080.9	18068	Ø 50	80 cm	1105.40

Ürün Kodu	Kısa Kod	Çıkış	Ölçü	Fiyat
4045.0A050K.033.9	18070	Ø 50	33 cm	596.70
4045.0A050K.045.9	18072	Ø 50	45 cm	683.40
4045.0A050K.060.9	18074	Ø 50	60 cm	850.00
4045.0A050K.080.9	18076	Ø 50	80 cm	1105.40



- Duş kanalı
- Ø 50 yan - alt çıkış
- Paslanmaz gövde
- Yükseklik ayarlı paslanmaz ızgara
- Sulu koku tutucu

ÜRÜN KODU KISA KOD ÇIKIŞ ÖLÇÜ FİYAT PREMIUM 360°

Ürün Kodu	Kısa Kod	Çıkış	Ölçü	Fiyat
4045.00360K.033.9	18078	Ø 50	33 cm	613.40
4045.00360K.045.9	18081	Ø 50	45 cm	716.70
4045.00360K.060.9	18083	Ø 50	60 cm	866.70
4045.00360K.080.9	18085	Ø 50	80 cm	1120.40



- Duş kanalı
- Ø 50 yan çıkış
- Paslanmaz gövde
- Yükseklik ayarlı paslanmaz çerçeve
- Yükseklik ayarlı paslanmaz ızgara
- Sulu koku tutucu

ÜRÜN KODU KISA KOD ÇIKIŞ ÖLÇÜ FİYAT LINE

YAN ÇIKIŞ

4072.0Y050K.020.1	18154	Ø 50	20x20 cm	12	155.00
-------------------	-------	------	----------	----	--------



ALT ÇIKIŞ

4072.0A050K.020.1	18156	Ø 50	20x20 cm	12	155.00
-------------------	-------	------	----------	----	--------



ÜRÜN KODU KISA KOD ÇIKIŞ ÖLÇÜ FİYAT LEGAL

YAN ÇIKIŞ

4073.0Y050K.020.1	18160	Ø 50	20x20 cm	12	273.40
-------------------	-------	------	----------	----	--------



ALT ÇIKIŞ

4073.0A050K.020.1	18164	Ø 50	20x20 cm	12	273.40
-------------------	-------	------	----------	----	--------



ÜRÜN KODU KISA KOD ÇIKIŞ ÖLÇÜ FİYAT LEGAL 360°

4073.00360K.020.1	18170	Ø 50	20x20cm	12	276.70
-------------------	-------	------	---------	----	--------

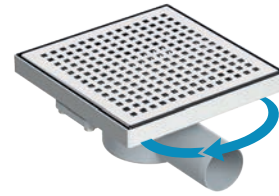

ÜRÜN KODU KISA KOD ÇIKIŞ ÖLÇÜ FİYAT LEGAL Y360°

4073.0Y360K.020.1	18176	Ø 50	20x20cm	12	293.40
-------------------	-------	------	---------	----	--------

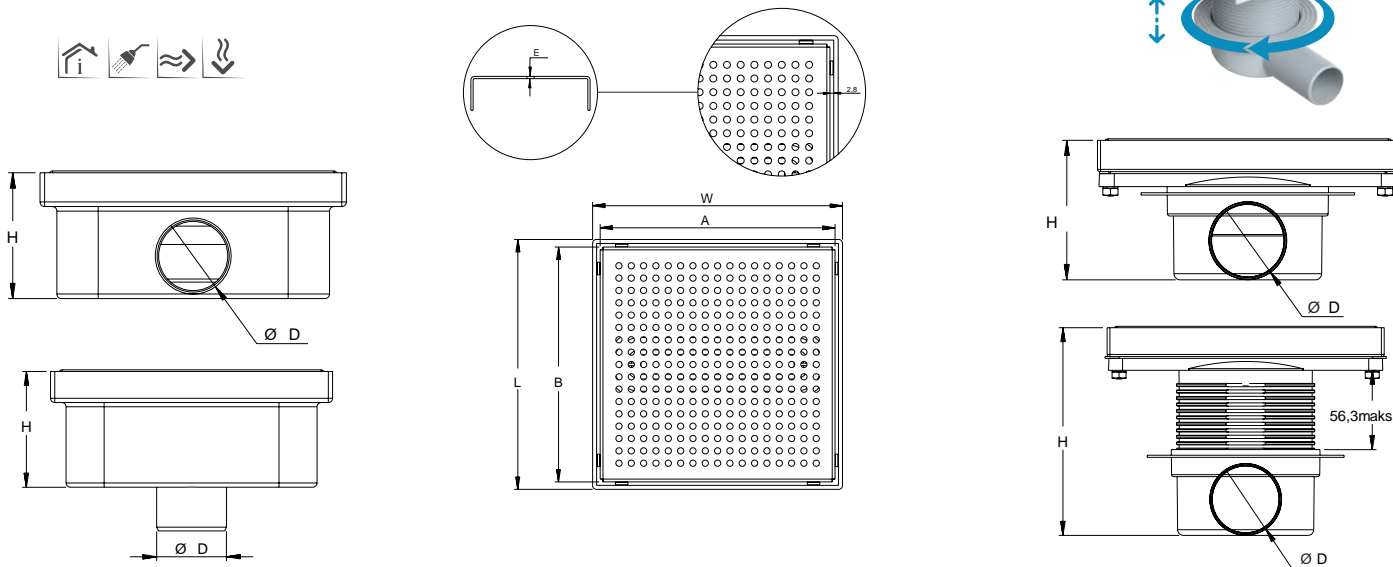
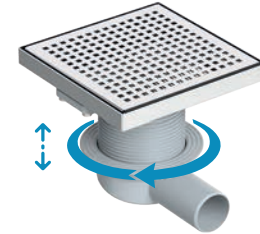

DOLU



KARE

ÜRÜN KODU	W	L	H	Ø D	A	B	E
4072.0Y050K.020.0	200	200	82	49.5	188	188	1.5
4072.0A050K.020.0	200	200	82	49.5	188	188	1.5

ÜRÜN KODU	W	L	H	Ø D	A	B	E
4073.00360K.020.0	200	200	91	49.5	188	188	1.5
4073.0Y360K.020.0	200	200	148	49.5	188	188	1.5

LINE

YAN ÇIKIŞ

Ürün Kodu	Kısa Kod	Çıkış	Ölçü	Fiyat	
4062.0Y050K.033.1	18117	Ø 50	33 cm	12	131.70

ALT ÇIKIŞ

Ürün Kodu	Kısa Kod	Çıkış	Ölçü	Fiyat	
4062.0A050K.033.1	18121	Ø 50	33 cm	12	131.70



LEGAL

YAN ÇIKIŞ

Ürün Kodu	Kısa Kod	Çıkış	Ölçü	Fiyat	
4063.0Y050K.033.1	18137	Ø 50	33 cm	12	231.70

ALT ÇIKIŞ

Ürün Kodu	Kısa Kod	Çıkış	Ölçü	Fiyat	
4063.0A050K.033.1	18140	Ø 50	33 cm	12	231.70



LEGAL 360°

Ürün Kodu	Kısa Kod	Çıkış	Ölçü	Fiyat	
4063.00360K.033.1	18146	Ø 50	33 cm	12	233.40

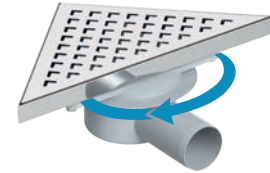

LEGAL Y360°

Ürün Kodu	Kısa Kod	Çıkış	Ölçü	Fiyat	
4063.0Y360K.033.1	18150	Ø 50	33 cm	12	256.70

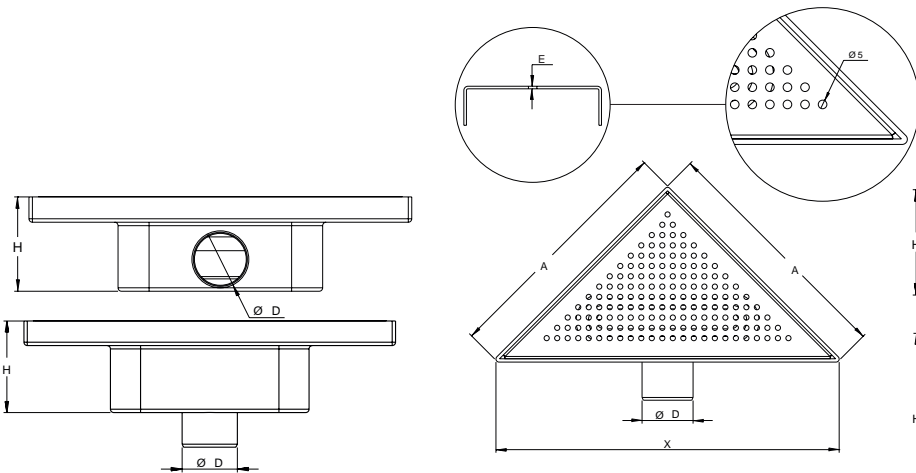
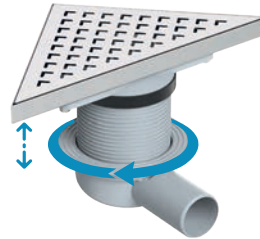

ÜRÜN KODU	H	Ø D	A	X	E
4062.0Y050K.033.0	84	49.5	234	330	1.5

ÜRÜN KODU	H	Ø D	A	X	E
4062.0A050K.033.0	84	49.5	234	330	1.5

ÜRÜN KODU	H	Ø D	A	X	E
4063.00360K.033.0	91	49.5	234	330	1.5

ÜRÜN KODU	H	Ø D	A	X	E
4063.0Y360K.033.0	147	49.5	234	330	1.5



DOLU



KARE

YENİ!

ÜRÜN KODU KISA KOD ÇIKIŞ ÖLÇÜ FİYAT EKO 10x10

ÜRÜN KODU	KISA KOD	ÇIKIŞ	ÖLÇÜ	FİYAT
3011.0Y050K.010.1	26583	Ø 50	10x10 cm	15.70



- Plastik gövde
- Paslanmaz ızgara
- Sulu koku tutucu

ÜRÜN KODU KISA KOD ÇIKIŞ ÖLÇÜ FİYAT LINE 10x10

ÜRÜN KODU	KISA KOD	ÇIKIŞ	ÖLÇÜ	FİYAT
3012.0Y032K.010.1	13795	Ø 32	10x10 cm	25.00
3012.0Y040K.010.1	13800	Ø 40	10x10 cm	26.00
3012.0Y050K.010.1	13805	Ø 50	10x10 cm	25.00
3012.0Y070K.010.1	13812	Ø 70	10x10 cm	26.70

ÜRÜN KODU	KISA KOD	ÇIKIŞ	ÖLÇÜ	FİYAT
3012.0A040K.010.1	13818	Ø 40	10x10 cm	28.40
3012.0A050K.010.1	13826	Ø 50	10x10 cm	26.70
3012.0A070K.010.1	13832	Ø 70	10x10 cm	28.40



- Plastik gövde
- Paslanmaz ızgara
- Sulu koku tutucu
- Klepeli

ELİTE LİNE

ÜRÜN KODU	KISA KOD	ÇIKIŞ	ÖLÇÜ	FİYAT
3012.0Y032K.010.B	28909	Ø 32	10x10 cm	30.00
3012.0Y050K.010.B	28910	Ø 50	10x10 cm	33.40

ÜRÜN KODU KISA KOD ÇIKIŞ ÖLÇÜ FİYAT LINE 15x15

ÜRÜN KODU	KISA KOD	ÇIKIŞ	ÖLÇÜ	FİYAT
3012.0Y032K.015.1	13882	Ø 32	15x15 cm	36.70
3012.0Y040K.015.1	13888	Ø 40	15x15 cm	40.00
3012.0Y050K.015.1	13896	Ø 50	15x15 cm	40.00
3012.0Y070K.015.1	13903	Ø 70	15x15 cm	41.70

ÜRÜN KODU	KISA KOD	ÇIKIŞ	ÖLÇÜ	FİYAT
3012.0A040K.015.1	13911	Ø 40	15x15 cm	41.70
3012.0A050K.015.1	13926	Ø 50	15x15 cm	40.00
3012.0A070K.015.1	13933	Ø 70	15x15 cm	41.70



- Plastik gövde
- Paslanmaz ızgara
- Sulu koku tutucu
- Klepeli

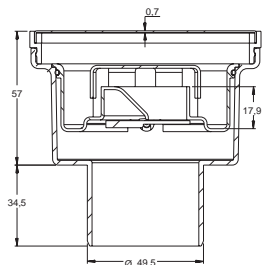
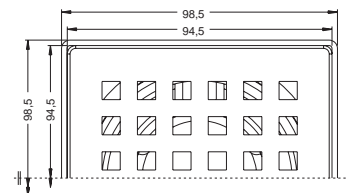
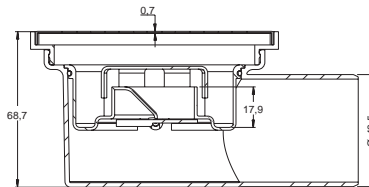
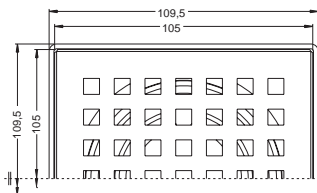

Ürünlerimiz  göre üretilmiştir.

LINE GOLD 10x10

Ürün Kodu	Kısa Kod	Çıkış	Ölçü	Fiyat
3012.0Y032G.010.1	13839	Ø 32	10x10 cm	29.00
3012.0Y040G.010.1	13843	Ø 40	10x10 cm	30.00
3012.0Y050G.010.1	13848	Ø 50	10x10 cm	30.00
3012.0Y070G.010.1	13853	Ø 70	10x10 cm	33.40

Ürün Kodu	Kısa Kod	Çıkış	Ölçü	Fiyat
3012.0A040G.010.1	13859	Ø 40	10x10 cm	30.00
3012.0A050G.010.1	13868	Ø 50	10x10 cm	30.00
3012.0A070G.010.1	13873	Ø 70	10x10 cm	31.70

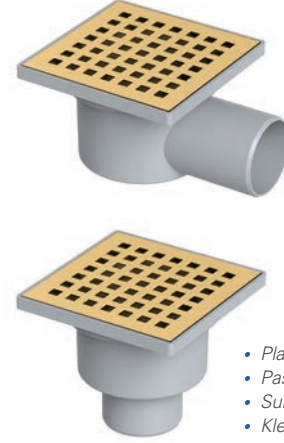

- Plastik gövde
- Paslanmaz ızgara
- Sulu koku tutucu
- Klepeli

LINE GOLD 15x15

Ürün Kodu	Kısa Kod	Çıkış	Ölçü	Fiyat
3012.0Y032G.015.1	13884	Ø 32	15x15 cm	48.40
3012.0Y040G.015.1	13892	Ø 40	15x15 cm	51.70
3012.0Y050G.015.1	13904	Ø 50	15x15 cm	50.00
3012.0Y070G.015.1	13912	Ø 70	15x15 cm	53.40

Ürün Kodu	Kısa Kod	Çıkış	Ölçü	Fiyat
3012.0A040G.015.1	13917	Ø 40	15x15 cm	51.70
3012.0A050G.015.1	13923	Ø 50	15x15 cm	50.00
3012.0A070G.015.1	13930	Ø 70	15x15 cm	53.40

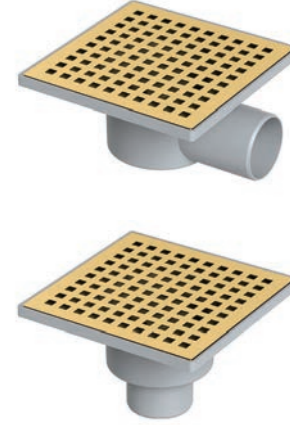

- Plastik gövde
- Paslanmaz ızgara
- Sulu koku tutucu
- Klepeli

Detaylar

DN 50 Yan ve Alt çıkış – Pvc boru bağlantılarına uyumludur. Akış hızı 32 lt/dk'dır. Izgarası 304 kalite paslanmaz çeliktir.

Avantajlar

304 kalite paslanmaz çelik ızgarası sayesinde şık ve kaliteli bir görünüme sahiptir. Duvar dibi uygulamalarda rahatlıkla uygulanabilir. Su tutuculu koku önleyici sayesinde tesisattan gelecek kötü kokuları önler. Yükseltme ayakları sayesinde şapın yüksekliğine göre ayarlama olanağı sağlar. Organik ve inorganik kimyasallara yüksek dayanım, çoğu asidik ve tuzlu su oksidasyonuna dayanıklıdır.

Kullanım Alanları

Genel kullanım banyo duşları, hastane ve otel duş alanları, soyunma odaları duş alanları vb.

Özel Üretim

Izgara modeli olarak istediğimize göre altın, bronz gibi renkler de üretilmektedir.

Uyarı

Yüksek yoğunluklu temizlik malzemelerinin uzun süreli kullanımı tavsiye edilmez.

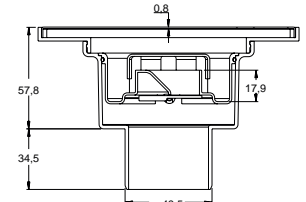
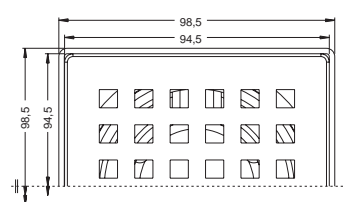
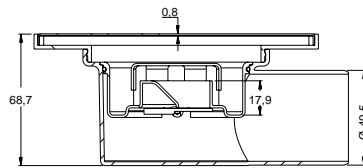
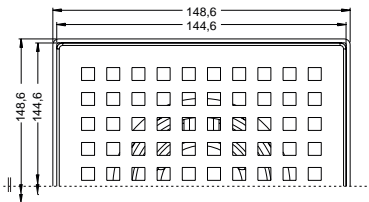

KARE
79

ENDEKS

Ürünlerimiz  göre üretilmiştir.

Ürün Kodu

Kısa Kod

Çıkış

Ölçü



Fiyat

LEGAL 10x10

3013.0Y032K.010.1	13940	Ø 32	10x10 cm	75	36.70
3013.0Y040K.010.1	13950	Ø 40	10x10 cm	50	41.70
3013.0Y050K.010.1	13960	Ø 50	10x10 cm	50	40.00
3013.0Y070K.010.1	13969	Ø 70	10x10 cm	30	43.40

3013.0A040K.010.1	13976	Ø 40	10x10 cm	60	43.40
3013.0A050K.010.1	13990	Ø 50	10x10 cm	60	40.00
3013.0A070K.010.1	13998	Ø 70	10x10 cm	60	43.40

ELİTE LEGAL

3013.0Y032K.010.B	28911	Ø 32	10x10 cm	40	45.00
3013.0Y050K.010.B	28912	Ø 50	10x10 cm	40	46.00



- Plastik gövde
- Paslanmaz ızgara
- Sulu koku tutucu
- Klepeli

Ürün Kodu

Kısa Kod

Çıkış

Ölçü



Fiyat

LEGAL 15x15

3013.0Y032K.015.1	13949	Ø 32	15x15 cm	40	60.00
3013.0Y040K.015.1	13968	Ø 40	15x15 cm	30	61.70
3013.0Y050K.015.1	13977	Ø 50	15x15 cm	30	60.00
3013.0Y070K.015.1	13981	Ø 70	15x15 cm	20	63.40

3013.0A040K.015.1	13989	Ø 40	15x15 cm	30	63.40
3013.0A050K.015.1	13996	Ø 50	15x15 cm	30	60.00
3013.0A070K.015.1	14006	Ø 70	15x15 cm	30	63.40

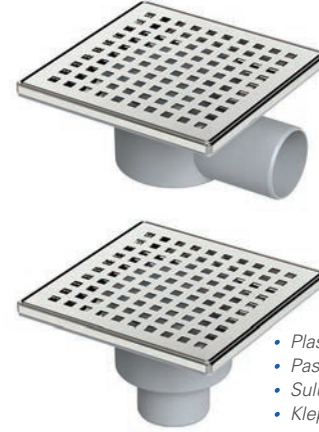

- Plastik gövde
- Paslanmaz ızgara
- Sulu koku tutucu
- Klepeli

Detaylar

DN 50 Yan ve Alt çıkış – Pvc boru bağlantılarına uyumludur. Akış hızı 32 lt/dk'dır. Izgarası 304 kalite paslanmaz çeliktir.

Avantajlar

304 kalite paslanmaz çelik izgarası sayesinde şık ve kaliteli bir görünüme sahiptir. Duvar dibi uygulamalarda rahatlıkla uygulanabilir. Su tutuculu koku önleyici sayesinde tesisat-tan gelecek kötü kokuları önler. Yükseltme ayakları sayesinde şapın yüksekliğine göre ayarlama olanağı sağlar. Organik ve inorganik kimyasallara yüksek dayanım, çoğu asidik ve tuzlu su oksidasyonuna dayanıklıdır.

Kullanım Alanları

Genel kullanım banyo duşları, hastane ve otel duş alanları, soyunma odaları duş alanları vb.

Özel Üretim

Izgara modeli olarak isteğinize göre altın, bronz gibi renkler de üretilmektedir.

Uyarı

Yüksek yoğunluklu temizlik malzemelerinin uzun süreli kullanımı tavsiye edilmez.

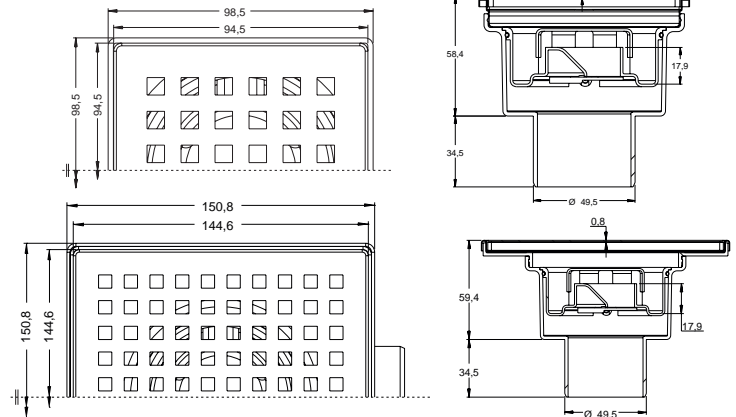
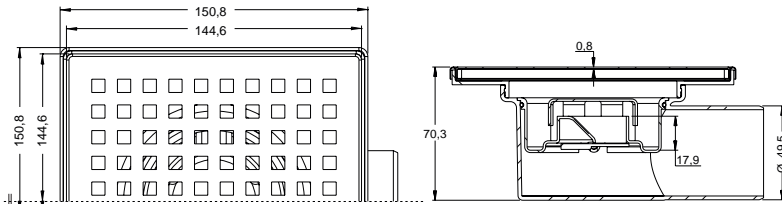
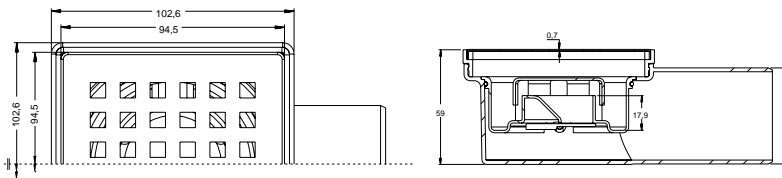

KARE

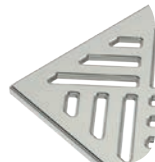

ENDEKS

Ürünlerimiz



göre üretilmiştir.

ÜRÜN KODU KISA KOD ÇIKIŞ ÖLÇÜ FİYAT KUCA

5710.0A050K.010.1 13939 Ø 50 10x10 cm 60 28.40

5710.0A070K.010.1 13941 Ø 70 10x10 cm 60 29.00



- Plastik gövde
- Paslanmaz ızgara

ÜRÜN KODU KISA KOD ÇIKIŞ ÖLÇÜ FİYAT SCALA 10x10

YAN ÇIKIŞ

3014.0Y032K.010.9 14005 Ø 32 10x10 cm 50 28.40

3014.0Y050K.010.9 14011 Ø 50 10x10 cm 50 30.00

ALT ÇIKIŞ

3014.0A050K.010.9 14013 Ø 50 10x10 cm 50 30.00



- Plastik gövde
- Paslanmaz ızgara ve çerçeve
- Bariyerli koku tutucu

ÜRÜN KODU KISA KOD ÇIKIŞ ÖLÇÜ FİYAT SCALA 15x15

YAN ÇIKIŞ

3014.0Y032K.015.9 14014 Ø 32 15x15 cm 30 40.00

3014.0Y050K.015.9 14015 Ø 50 15x15 cm 30 41.70

ALT ÇIKIŞ

3014.0A050K.015.9 14017 Ø 50 15x15 cm 24 41.70



- Plastik gövde
- Paslanmaz ızgara
- Tekstil membranlı
- Sulu klepelı koku tutucu

ÜRÜN KODU KISA KOD ÇIKIŞ ÖLÇÜ FİYAT KÖŞE BALKON

6001.0A070.13.0 13942 Ø 70 125 33.40

6002.0A100.16.0 13945 Ø 100 64 36.70

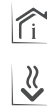

- Plastik gövde

Ürünlerimiz  göre üretilmiştir.

ÜRÜN KODU

KISA KOD

ÇIKIŞ

ÖLÇÜ



FİYAT

MİDİ 10x10

YAN ÇIKIŞ

5001.0Y032.010.1	14010	Ø 32	10x10 cm	30	36.70
5001.0Y040.010.1	14018	Ø 40	10x10 cm	20	41.70
5001.0Y050.010.1	14022	Ø 50	10x10 cm	20	36.70
5001.0Y070.010.1	14025	Ø 70	10x10 cm	20	40.00

ALT ÇIKIŞ

5001.0A040.010.1	14032	Ø 40	10x10 cm	20	38.40
5001.0A050.010.1	14035	Ø 50	10x10 cm	20	36.70
5001.0A070.010.1	14039	Ø 70	10x10 cm	20	38.40



- Plastik gövde
- Paslanmaz ızgara
- Sulu koku tutucu
- Klepeli

ÜRÜN KODU

KISA KOD

ÇIKIŞ

ÖLÇÜ



FİYAT

STD. 10x10

YAN ÇIKIŞ

5002.0Y032.010.1	14019	Ø 32	10x10 cm	30	53.40
5002.0Y040.010.1	14041	Ø 40	10x10 cm	20	58.40
5002.0Y050.010.1	14046	Ø 50	10x10 cm	20	56.70
5002.0Y070.010.1	14050	Ø 70	10x10 cm	20	61.70
5002.0Y100.010.1	14052	Ø 100	10x10 cm	10	70.00

ALT ÇIKIŞ

5002.0A040.010.1	14062	Ø 40	10x10 cm	20	55.00
5002.0A050.010.1	14067	Ø 50	10x10 cm	20	55.00
5002.0A070.010.1	14078	Ø 70	10x10 cm	20	55.00
5002.0A100.010.1	14083	Ø 100	10x10 cm	10	60.00



- Plastik gövde
- Paslanmaz ızgara
- Sulu koku tutucu
- Klepeli

ÜRÜN KODU

KISA KOD

ÇIKIŞ

ÖLÇÜ



FİYAT

FİLELİ 10x10

YAN ÇIKIŞ

5002.FY032.010.1	14059	Ø 32	10x10 cm	30	60.00
5002.FY040.010.1	14055	Ø 40	10x10 cm	20	61.70
5002.FY050.010.1	14061	Ø 50	10x10 cm	20	61.70
5002.FY070.010.1	14068	Ø 70	10x10 cm	20	63.40
5002.FY100.010.1	14073	Ø 100	10x10 cm	10	66.70

ALT ÇIKIŞ

5002.FA040.010.1	14077	Ø 40	10x10 cm	20	60.00
5002.FA050.010.1	14084	Ø 50	10x10 cm	20	60.00
5002.FA070.010.1	14088	Ø 70	10x10 cm	20	60.00
5002.FA100.010.1	14093	Ø 100	10x10 cm	10	61.70

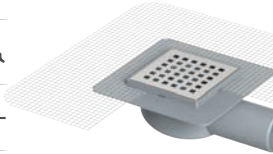

- Plastik gövde
- Paslanmaz ızgara
- Fileli
- Sulu klepeli koku tutucu

ÜRÜN KODU

KISA KOD

ÇIKIŞ

ÖLÇÜ



FİYAT

TEKSTİL MEMBRANLI 10x10

YAN ÇIKIŞ

5002.TY032.010.1	14091	Ø 32	10x10 cm	30	63.40
5002.TY040.010.1	14103	Ø 40	10x10 cm	20	63.40
5002.TY050.010.1	14107	Ø 50	10x10 cm	20	63.40
5002.TY070.010.1	14112	Ø 70	10x10 cm	20	66.70
5002.TY100.010.1	14120	Ø 100	10x10 cm	10	70.00

ALT ÇIKIŞ

5002.TA040.010.1	14124	Ø 40	10x10 cm	20	63.40
5002.TA050.010.1	14128	Ø 50	10x10 cm	20	63.40
5002.TA070.010.1	14132	Ø 70	10x10 cm	20	63.40
5002.TA100.010.1	14136	Ø 100	10x10 cm	10	66.70

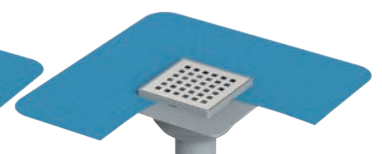
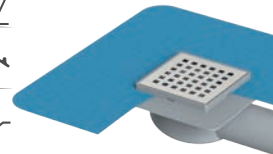

- Plastik gövde
- Paslanmaz ızgara
- Tekstil membranlı
- Sulu klepeli koku tutucu

Ürünlerimiz  göre üretilmiştir.



KARE



ENDEKS

ÜRÜN KODU KISA KOD ÇIKIŞ ÖLÇÜ FİYAT PREMIUM 10x10

Ürün Kodu	Kısa Kod	Çıkış	Ölçü	Fiyat
3045.0Y032K.010.1	14096	Ø 32	10x10 cm	24 106.70
3045.0Y050K.010.1	14097	Ø 50	10x10 cm	24 110.00
3045.0A050K.010.1	14099	Ø 50	10x10 cm	24 96.70



- Paslanmaz gövde
- Paslanmaz ızgara
- Paslanmaz koku tutucu

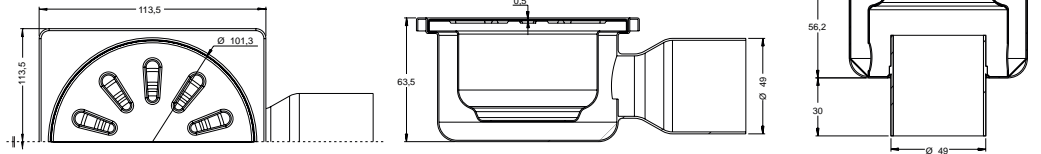

ÜRÜN KODU KISA KOD ÇIKIŞ ÖLÇÜ FİYAT PREMIUM 15x15

Ürün Kodu	Kısa Kod	Çıkış	Ölçü	Fiyat
3045.0Y032K.015.1	14100	Ø 32	15x15 cm	24 126.70
3045.0Y050K.015.1	14102	Ø 50	15x15 cm	24 130.00
3045.0Y070K.015.1	14104	Ø 70	15x15 cm	24 136.70
3045.0A050K.015.1	14108	Ø 50	15x15 cm	24 126.70
3045.0A070K.015.1	14111	Ø 70	15x15 cm	24 136.70



- Paslanmaz gövde
- Paslanmaz ızgara
- Paslanmaz koku tutucu

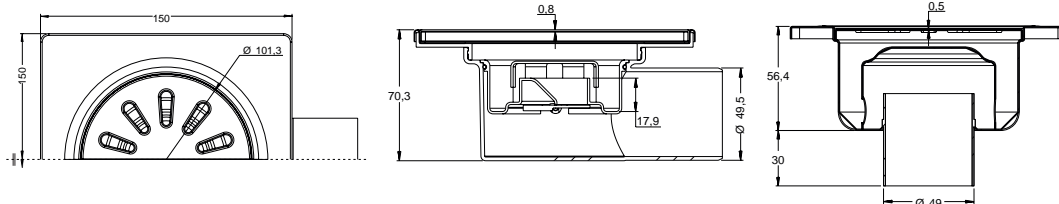

ÜRÜN KODU KISA KOD ÇIKIŞ ÖLÇÜ FİYAT PREMIUM 20x20

Ürün Kodu	Kısa Kod	Çıkış	Ölçü	Fiyat
3045.0Y070K.020.1	14115	Ø 70	20x20 cm	12 400.00
3045.0Y100K.020.1	14116	Ø 100	20x20 cm	12 436.70
3045.0A070K.020.1	14117	Ø 70	20x20 cm	12 400.00
3045.0A100K.020.1	14119	Ø 100	20x20 cm	12 433.40



- Paslanmaz gövde
- Paslanmaz ızgara
- Paslanmaz koku tutucu

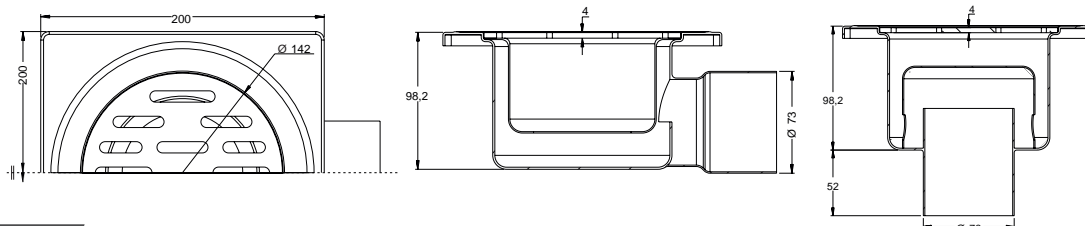

Ürünlerimiz  göre üretilmiştir.

LINE

10X10

Ürün Kodu	Kısa Kod	Çap	Ölçü	Fiyat
5101.0A100.10.1	14198	Ø 100	10x10 cm	44.40

15X15

Ürün Kodu	Kısa Kod	Çap	Ölçü	Fiyat
5107.0A100.15.1	14200	Ø 100	15x15 cm	58.40



- Plastik gövde
- Paslanmaz ızgara
- Sulu klepeli koku tutucu

LEGAL

10X10

Ürün Kodu	Kısa Kod	Çap	Ölçü	Fiyat
5102.0A100.10.1	14204	Ø 100	10x10 cm	51.70

15X15

Ürün Kodu	Kısa Kod	Çap	Ölçü	Fiyat
5108.0A100.15.1	14206	Ø 100	15x15 cm	66.70



- Plastik gövde
- Paslanmaz ızgara
- Sulu klepeli koku tutucu

PREMIUM

10X10

Ürün Kodu	Kısa Kod	Çap	Ölçü	Fiyat
5105.0A100.10.0	14207	Ø 100	10x10 cm	56.70

15X15

Ürün Kodu	Kısa Kod	Çap	Ölçü	Fiyat
5111.0A100.15.0	14209	Ø 100	15x15 cm	66.70



- Plastik gövde
- Paslanmaz ızgara
- Sulu klepeli koku tutucu

RING

RING

Ürün Kodu	Kısa Kod	Çap	Ölçü	Fiyat
1207001100100	14208	Ø 100	-	16.70

IZGARALI RING

Ürün Kodu	Kısa Kod	Çap	Ölçü	Fiyat
5112.0A100.00.1	14210	Ø 100	15x15 cm	36.70



- Yükseltme ara parçası

- Plastik gövde
- Paslanmaz ızgara
- Sulu klepeli koku tutucu



KARE

ENDEKS

Ürünlerimiz  göre üretilmiştir.

ÜRÜN KODU KISA KOD ÇAP ÖLÇÜ FİYAT SCALA 10x10

5103.0A100.10.0 14199 Ø 100 10x10 cm 120 22.50

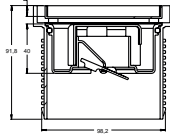
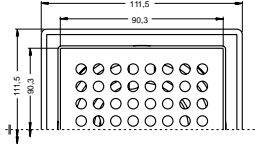

- Plastik gövde
- Sulu klepeli koku tutucu

ÜRÜN KODU KISA KOD ÇAP ÖLÇÜ FİYAT SCALA 15x15

5109.0A100.15.0 14202 Ø 100 15x15 cm 80 25.00

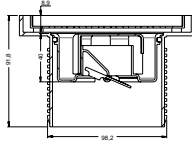
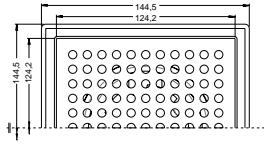

- Plastik gövde
- Sulu klepeli koku tutucu

ÜRÜN KODU KISA KOD ÇAP ÖLÇÜ FİYAT ELİT 10x10

5104.0A100.10.0 14203 Ø 100 10x10 cm 120 53.40

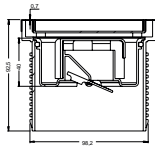
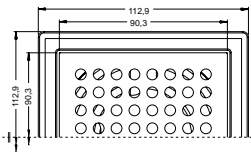

- Plastik gövde
- Paslanmaz ızgara
- Sulu klepeli koku tutucu

ÜRÜN KODU KISA KOD ÇAP ÖLÇÜ FİYAT ELİT 15x15

5110.0A100.15.0 14205 Ø 100 15x15 cm 80 64.00

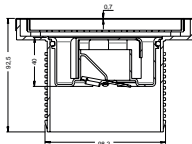
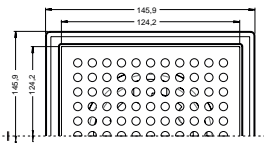

- Plastik gövde
- Paslanmaz ızgara
- Sulu klepeli koku tutucu

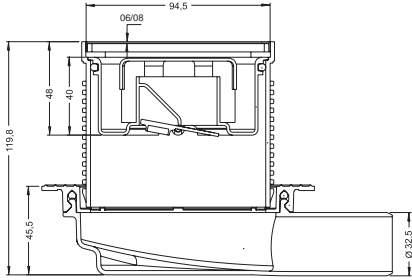
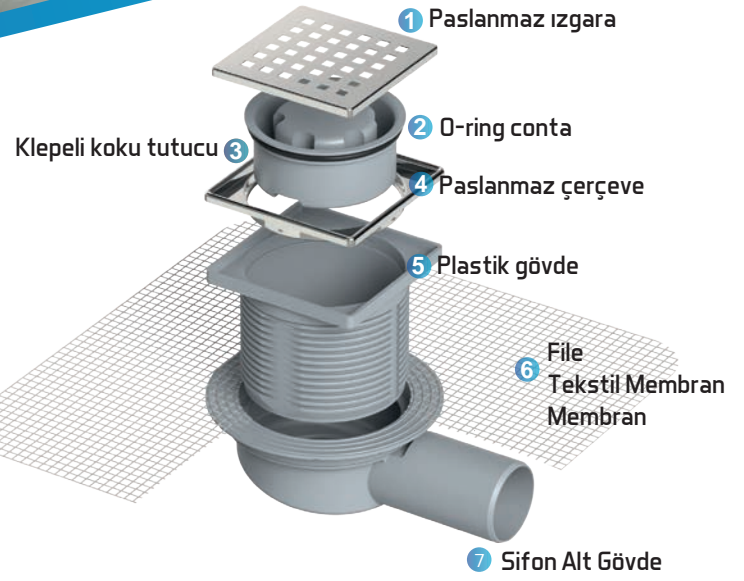

Ø 32 YAN ÇIKIŞ

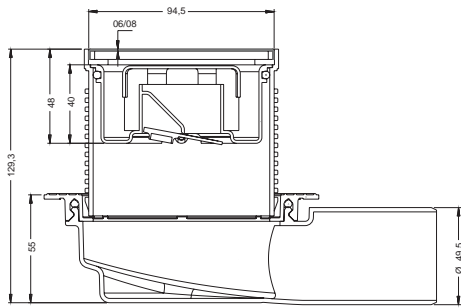
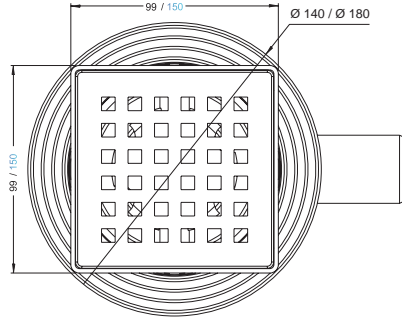

Ø 50 YAN ÇIKIŞ

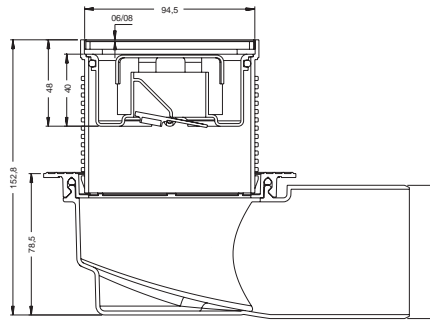

Ø 70 YAN ÇIKIŞ

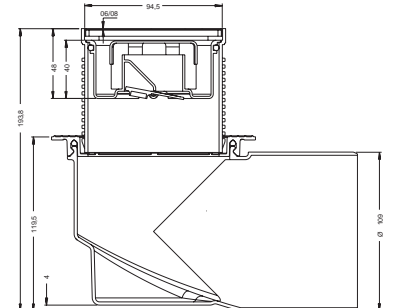

Ø 100 YAN ÇIKIŞ

SİFON ALT GÖVDE

140 MM DUVAR DİBİ

Ürün Kodu	Kısa Kod	Çıkış	Yükseklik		Fiyat
5014.0Y032.00.0	14212	Ø 32	46 mm	125	21.70
5014.0Y040.00.0	14213	Ø 40	55 mm	125	23.40
5014.0Y050.00.0	14215	Ø 50	55 mm	100	23.40
5014.0Y070.00.0	14224	Ø 70	79 mm	75	25.00
5014.0Y100.00.0	14225	Ø 100	115 mm	75	28.40



- Sifon alt gövde
- 140 mm flanşlı

5014.0A040.00.0	14226	Ø 40	96 mm	140	18.40
5014.0A050.00.0	14227	Ø 50	96 mm	140	18.40
5014.0A070.00.0	14228	Ø 70	96 mm	125	18.40
5014.0A100.00.0	14229	Ø 100	96 mm	75	20.00

180 MM

Ürün Kodu	Kısa Kod	Çıkış	Yükseklik		Fiyat
5018.0Y032.00.0	14211	Ø 32	46 mm	100	23.40
5018.0Y040.00.0	14214	Ø 40	55 mm	100	25.00
5018.0Y050.00.0	14216	Ø 50	55 mm	100	25.00
5018.0Y070.00.0	14217	Ø 70	79 mm	75	25.00
5018.0Y100.00.0	14218	Ø 100	115 mm	30	33.40

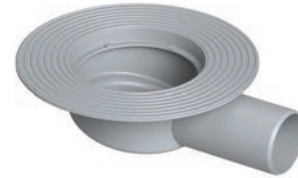

- Sifon alt gövde
- 180 mm flanşlı

5018.0A040.00.0	14219	Ø 40	96 mm	100	20.00
5018.0A050.00.0	14220	Ø 50	96 mm	100	20.00
5018.0A070.00.0	14221	Ø 70	96 mm	85	20.70
5018.0A100.00.0	14222	Ø 100	96 mm	75	21.70

210 MM

Ürün Kodu	Kısa Kod	Çıkış	Yükseklik		Fiyat
5021.0Y032.00.0	14231	Ø 32	46 mm	100	25.00
5021.0Y040.00.0	14232	Ø 40	55 mm	100	26.70
5021.0Y050.00.0	14233	Ø 50	55 mm	100	26.70
5021.0Y070.00.0	14234	Ø 70	79 mm	70	33.40
5021.0Y100.00.0	14236	Ø 100	115 mm	30	38.40

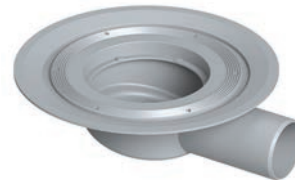

- Sifon alt gövde
- 210 mm flanşlı

5021.0A040.00.0	14237	Ø 40	96 mm	100	21.70
5021.0A050.00.0	14239	Ø 50	96 mm	100	21.70
5021.0A070.00.0	14241	Ø 70	96 mm	100	21.70
5021.0A100.00.0	14243	Ø 100	96 mm	70	23.40

ÜRÜN KODU KISA KOD ÇIKIŞ YÜKSEKLİK FİYAT 140 MM FİLELİ

Ürün Kodu	Kısa Kod	Çıkış	Yükseklik	Fiyat
5014.FY032.00.0	14230	Ø 32	46 mm	26.70
5014.FY040.00.0	14235	Ø 40	55 mm	28.40
5014.FY050.00.0	14238	Ø 50	55 mm	28.40
5014.FY070.00.0	14242	Ø 70	79 mm	31.70
5014.FY100.00.0	14244	Ø 100	115 mm	36.70



Ürün Kodu	Kısa Kod	Çıkış	Yükseklik	Fiyat
5014.FA040.00.0	14246	Ø 40	96 mm	23.40
5014.FA050.00.0	14247	Ø 50	96 mm	23.40
5014.FA070.00.0	14248	Ø 70	96 mm	24.00
5014.FA100.00.0	14249	Ø 100	96 mm	24.00

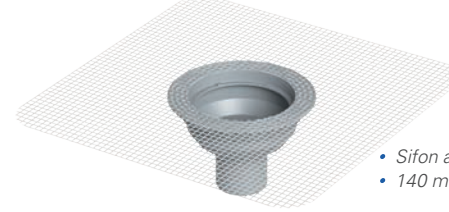
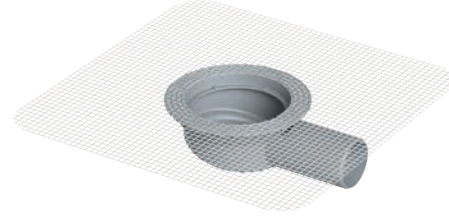

- Sifon alt gövde
- 140 mm fileli flanşlı

ÜRÜN KODU KISA KOD ÇIKIŞ YÜKSEKLİK FİYAT 180 MM FİLELİ

Ürün Kodu	Kısa Kod	Çıkış	Yükseklik	Fiyat
5018.FY032.00.0	14245	Ø 32	46 mm	26.70
5018.FY040.00.0	14250	Ø 40	55 mm	28.40
5018.FY050.00.0	14251	Ø 50	55 mm	28.40
5018.FY070.00.0	14253	Ø 70	79 mm	31.70
5018.FY100.00.0	14255	Ø 100	115 mm	35.00



Ürün Kodu	Kısa Kod	Çıkış	Yükseklik	Fiyat
5018.FA040.00.0	14262	Ø 40	96 mm	25.00
5018.FA050.00.0	14265	Ø 50	96 mm	25.00
5018.FA070.00.0	14266	Ø 70	96 mm	25.00
5018.FA100.00.0	14267	Ø 100	96 mm	28.40

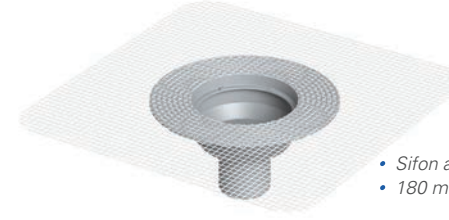
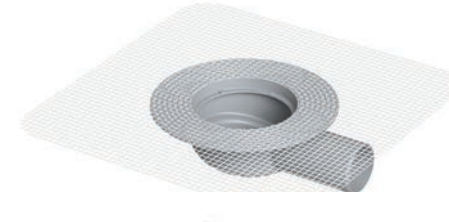

- Sifon alt gövde
- 180 mm fileli flanşlı

ÜRÜN KODU KISA KOD ÇIKIŞ YÜKSEKLİK FİYAT 140 MM T.MEMBRANLI

Ürün Kodu	Kısa Kod	Çıkış	Yükseklik	Fiyat
5014.TY032.00.0	14252	Ø 32	46 mm	31.70
5014.TY040.00.0	14254	Ø 40	55 mm	33.40
5014.TY050.00.0	14256	Ø 50	55 mm	33.40
5014.TY070.00.0	14257	Ø 70	79 mm	38.40
5014.TY100.00.0	14258	Ø 100	115 mm	41.70



Ürün Kodu	Kısa Kod	Çıkış	Yükseklik	Fiyat
5014.TA040.00.0	14259	Ø 40	96 mm	30.00
5014.TA050.00.0	14260	Ø 50	96 mm	30.00
5014.TA070.00.0	14261	Ø 70	96 mm	30.70
5014.TA100.00.0	14263	Ø 100	96 mm	30.70

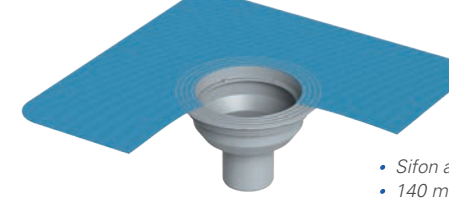
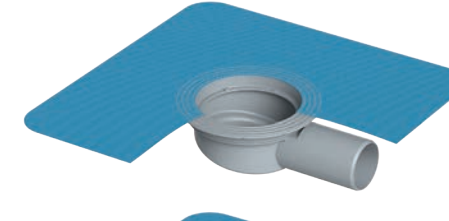

- Sifon alt gövde
- 140 mm Tekstil Membranlı flanşlı

Ürün Kodu

Kısa Kod

Çıkış

Yükseklik



Fiyat

180 MM T.MEMBRANLI

5018.TY032.00.0	14264	Ø 32	46 mm	100	31.70
5018.TY040.00.0	14268	Ø 40	55 mm	100	32.70
5018.TY050.00.0	14270	Ø 50	55 mm	90	32.70
5018.TY070.00.0	14271	Ø 70	79 mm	75	36.70
5018.TY100.00.0	14272	Ø 100	115 mm	50	40.00



5018.TA040.00.0	14273	Ø 40	96 mm	85	31.00
5018.TA050.00.0	14276	Ø 50	96 mm	85	31.00
5018.TA070.00.0	14278	Ø 70	96 mm	75	31.00
5018.TA100.00.0	14280	Ø 100	96 mm	75	31.00

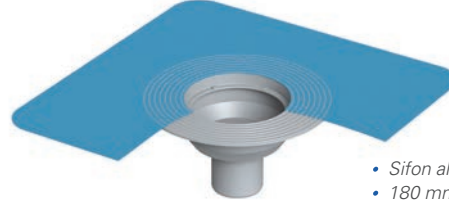
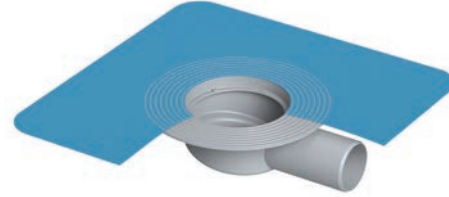

- Sifon alt gövde
- 180 mm tekstil membranlı flanşlı

Ürün Kodu

Kısa Kod

Çıkış

Yükseklik



Fiyat

210 MM MEMBRANLI

5021.MY032.00.0	14269	Ø 32	50 mm	35	60.00
5021.MY040.00.0	14274	Ø 40	59 mm	35	60.40
5021.MY050.00.0	14277	Ø 50	59 mm	35	60.40
5021.MY070.00.0	14279	Ø 70	84 mm	30	65.00
5021.MY100.00.0	14281	Ø 100	119 mm	30	66.70



5021.MA040.00.0	14283	Ø 40	100 mm	30	59.00
5021.MA050.00.0	14284	Ø 50	100 mm	30	59.00
5021.MA070.00.0	14285	Ø 70	100 mm	30	59.00
5021.MA100.00.0	14287	Ø 100	100 mm	30	59.00

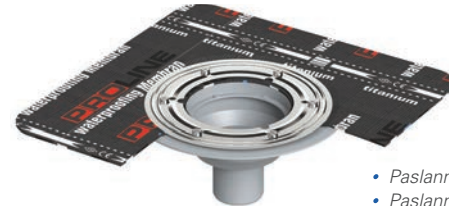
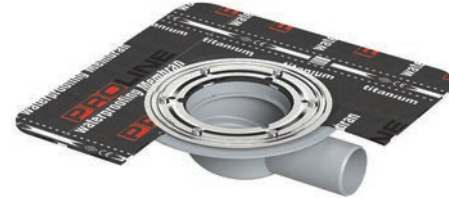

- Paslanmaz gövde
- Paslanmaz flanş takımı
- Bitüm membranlı

ALT ÇIKIŞ ÖLÇÜLERİ

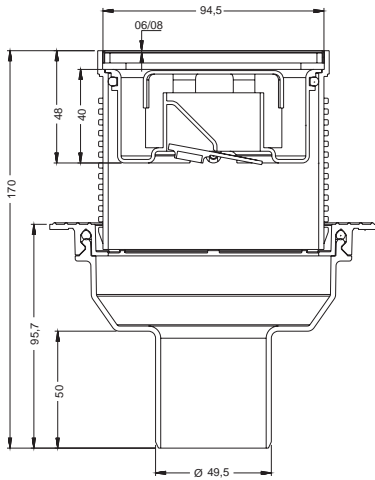

Ø 50 ALT ÇIKIŞ

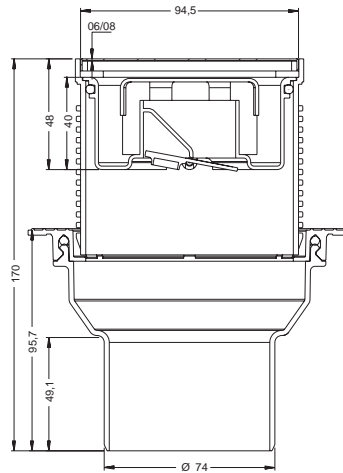

Ø 70 ALT ÇIKIŞ

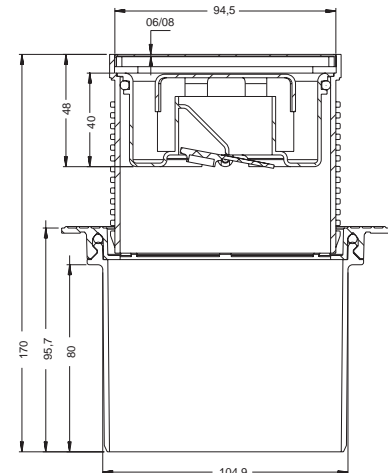

Ø 100 ALT ÇIKIŞ

Ürün Kodu

Kısa Kod

Çıkış

Ölçü



Fiyat

140 MM 10x10 DUVAR DİBİ

5054.OY032.10.1	14282	Ø 32	10x10 cm	50	60.00
5054.OY040.10.1	14286	Ø 40	10x10 cm	50	60.00
5054.OY050.10.1	14289	Ø 50	10x10 cm	50	60.00
5054.OY070.10.1	14290	Ø 70	10x10 cm	50	63.40
5054.OY100.10.1	14291	Ø 100	10x10 cm	50	66.70



5054.OA040.10.1	14292	Ø 40	10x10 cm	50	58.70
5054.OA050.10.1	14293	Ø 50	10x10 cm	50	58.70
5054.OA070.10.1	14294	Ø 70	10x10 cm	50	58.70
5054.OA100.10.1	14295	Ø 100	10x10 cm	50	58.70



- Plastik gövde
- Paslanmaz ızgara
- Sulu klepeli koku tutucu
- 140 mm flanşlı

Ürün Kodu

Kısa Kod

Çıkış

Ölçü



Fiyat

180 MM 10x10

5058.OY032.10.1	14288	Ø 32	10x10 cm	50	61.70
5058.OY040.10.1	14296	Ø 40	10x10 cm	50	61.70
5058.OY050.10.1	14299	Ø 50	10x10 cm	50	61.70
5058.OY070.10.1	14302	Ø 70	10x10 cm	50	65.00
5058.OY100.10.1	14303	Ø 100	10x10 cm	50	68.40



5058.OA040.10.1	14305	Ø 40	10x10 cm	50	60.00
5058.OA050.10.1	14307	Ø 50	10x10 cm	50	60.00
5058.OA070.10.1	14309	Ø 70	10x10 cm	50	60.00
5058.OA100.10.1	14311	Ø 100	10x10 cm	50	60.00



- Plastik gövde
- Paslanmaz ızgara
- Sulu klepeli koku tutucu
- 180 mm flanşlı

Ürün Kodu

Kısa Kod

Çıkış

Ölçü



Fiyat

180 MM 15x15

5058.OY032.15.1	14298	Ø 32	15x15cm	50	76.70
5058.OY040.15.1	14300	Ø 40	15x15cm	50	78.40
5058.OY050.15.1	14301	Ø 50	15x15cm	50	78.40
5058.OY070.15.1	14304	Ø 70	15x15cm	50	83.40
5058.OY100.15.1	14306	Ø 100	15x15cm	50	90.00



5058.OA040.15.1	14308	Ø 40	15x15cm	50	75.00
5058.OA050.15.1	14310	Ø 50	15x15cm	50	75.00
5058.OA070.15.1	14312	Ø 70	15x15cm	50	75.00
5058.OA100.15.1	14314	Ø 100	15x15cm	50	75.00



- Plastik gövde
- Paslanmaz ızgara
- Sulu klepeli koku tutucu
- 180 mm flanşlı

Ürünlerimiz  göre üretilmiştir.

140 MM 10x10 FİLELİ

Ürün Kodu	Kısa Kod	Çıkış	Ölçü	Fiyat
5054.FY032.10.1	14313	Ø 32	10x10 cm	63.40
5054.FY040.10.1	14319	Ø 40	10x10 cm	63.40
5054.FY050.10.1	14321	Ø 50	10x10 cm	63.40
5054.FY070.10.1	14322	Ø 70	10x10 cm	66.70
5054.FY100.10.1	14323	Ø 100	10x10 cm	73.40



Ürün Kodu	Kısa Kod	Çıkış	Ölçü	Fiyat
5054.FA040.10.1	14324	Ø 40	10x10 cm	61.70
5054.FA050.10.1	14325	Ø 50	10x10 cm	61.70
5054.FA070.10.1	14326	Ø 70	10x10 cm	61.70
5054.FA100.10.1	14327	Ø 100	10x10 cm	61.70

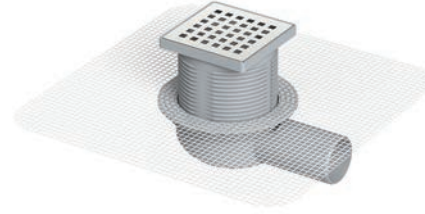

- Plastik gövde
- Paslanmaz ızgara
- Sulu klepelili koku tutucu
- 140 mm fileli flanşlı

180 MM 10x10 FİLELİ

Ürün Kodu	Kısa Kod	Çıkış	Ölçü	Fiyat
5058.FY032.10.1	14315	Ø 32	10x10 cm	65.00
5058.FY040.10.1	14316	Ø 40	10x10 cm	65.00
5058.FY050.10.1	14317	Ø 50	10x10 cm	65.00
5058.FY070.10.1	14318	Ø 70	10x10 cm	68.40
5058.FY100.10.1	14320	Ø 100	10x10 cm	71.70



Ürün Kodu	Kısa Kod	Çıkış	Ölçü	Fiyat
5058.FA040.10.1	14328	Ø 40	10x10 cm	63.40
5058.FA050.10.1	14330	Ø 50	10x10 cm	63.40
5058.FA070.10.1	14331	Ø 70	10x10 cm	63.40
5058.FA100.10.1	14332	Ø 100	10x10 cm	63.40

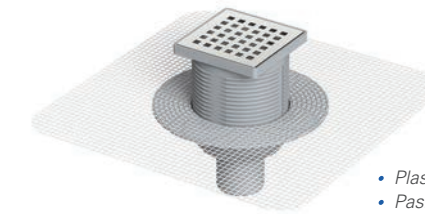
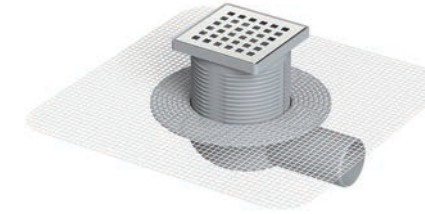

- Plastik gövde
- Paslanmaz ızgara
- Sulu klepelili koku tutucu
- 180 mm fileli flanşlı

180 MM 15x15 FİLELİ

Ürün Kodu	Kısa Kod	Çıkış	Ölçü	Fiyat
5058.FY032.15.1	14333	Ø 32	15x15cm	86.70
5058.FY040.15.1	14334	Ø 40	15x15cm	88.40
5058.FY050.15.1	14335	Ø 50	15x15cm	88.40
5058.FY070.15.1	14336	Ø 70	15x15cm	90.00
5058.FY100.15.1	14337	Ø 100	15x15cm	96.70



Ürün Kodu	Kısa Kod	Çıkış	Ölçü	Fiyat
5058.FA040.15.1	14338	Ø 40	15x15cm	85.00
5058.FA050.15.1	14340	Ø 50	15x15cm	85.00
5058.FA070.15.1	14341	Ø 70	15x15cm	85.00
5058.FA100.15.1	14344	Ø 100	15x15cm	85.00

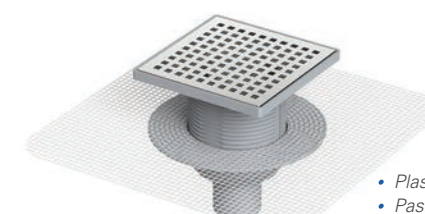
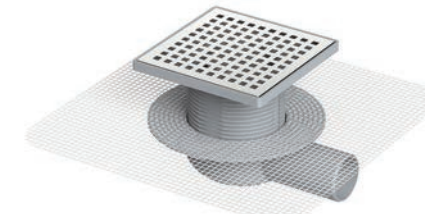

- Plastik gövde
- Paslanmaz ızgara
- Sulu klepelili koku tutucu
- 180 mm fileli flanşlı

Ürünlerimiz  göre üretilmiştir.

Ürün Kodu

Kısa Kod

Çıkış

Ölçü



Fiyat

140 MM 10x10 T.MEMBRANLI

5054.TY032.10.1	14342	Ø 32	10x10 cm	50	71.70
5054.TY040.10.1	14346	Ø 40	10x10 cm	50	73.40
5054.TY050.10.1	14349	Ø 50	10x10 cm	50	73.40
5054.TY070.10.1	14351	Ø 70	10x10 cm	50	75.00
5054.TY100.10.1	14353	Ø 100	10x10 cm	50	80.00



5054.TA040.10.1	14356	Ø 40	10x10 cm	50	70.00
5054.TA050.10.1	14357	Ø 50	10x10 cm	50	73.40
5054.TA070.10.1	14359	Ø 70	10x10 cm	50	73.40
5054.TA100.10.1	14361	Ø 100	10x10 cm	50	76.70

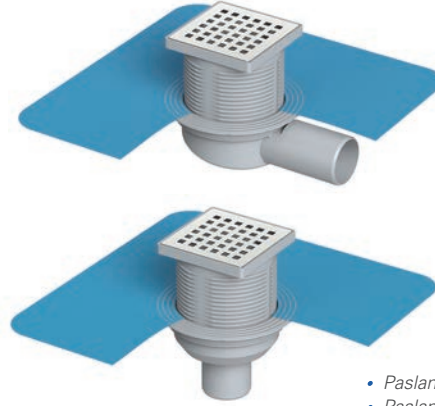

- Paslanmaz gövde
- Paslanmaz ızgara
- Sulu klepelili koku tutucu
- 140 mm tekstil membranlı flanşlı

Ürün Kodu

Kısa Kod

Çıkış

Ölçü



Fiyat

180 MM 10x10 T.MEMBRANLI

5058.TY032.10.1	14345	Ø 32	10x10 cm	50	73.40
5058.TY040.10.1	14348	Ø 40	10x10 cm	50	75.00
5058.TY050.10.1	14350	Ø 50	10x10 cm	50	75.00
5058.TY070.10.1	14352	Ø 70	10x10 cm	50	76.70
5058.TY100.10.1	14354	Ø 100	10x10 cm	50	80.00



5058.TA040.10.1	14355	Ø 40	10x10 cm	50	70.00
5058.TA050.10.1	14358	Ø 50	10x10 cm	50	71.70
5058.TA070.10.1	14360	Ø 70	10x10 cm	50	71.70
5058.TA100.10.1	14362	Ø 100	10x10 cm	50	73.40

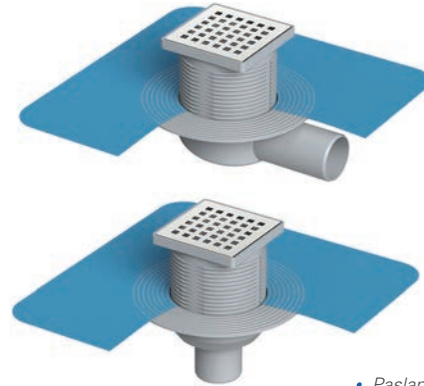

- Paslanmaz gövde
- Paslanmaz ızgara
- Sulu klepelili koku tutucu
- 180 mm tekstil membranlı flanşlı

Ürün Kodu

Kısa Kod

Çıkış

Ölçü



Fiyat

180 MM 15x15 T.MEMBRANLI

5058.TY032.15.1	14364	Ø 32	15x15cm	50	93.40
5058.TY040.15.1	14365	Ø 40	15x15cm	50	95.00
5058.TY050.15.1	14366	Ø 50	15x15cm	50	95.00
5058.TY070.15.1	14367	Ø 70	15x15cm	50	98.40
5058.TY100.15.1	14368	Ø 100	15x15cm	50	101.70



5058.TA040.15.1	14369	Ø 40	15x15cm	50	93.40
5058.TA050.15.1	14370	Ø 50	15x15cm	50	95.00
5058.TA070.15.1	14371	Ø 70	15x15cm	50	95.00
5058.TA100.15.1	14372	Ø 100	15x15cm	50	96.70

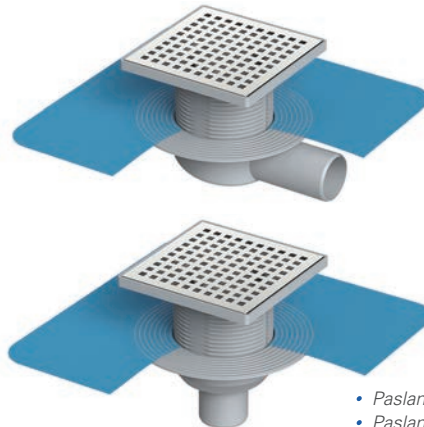

- Paslanmaz gövde
- Paslanmaz ızgara
- Sulu klepelili koku tutucu
- 180 mm tekstil membranlı flanşlı

Ürünlerimiz  göre üretilmiştir.

Ürün Kodu

Kısa Kod

Çıkış

Ölçü



Fiyat

210 MM 10x10 MEMBRANLI

5061.MY032.10.1	14363	Ø 32	10x10 cm	50	96.70
5061.MY040.10.1	14373	Ø 40	10x10 cm	50	98.40
5061.MY050.10.1	14374	Ø 50	10x10 cm	50	98.40
5061.MY070.10.1	14375	Ø 70	10x10 cm	50	101.70
5061.MY100.10.1	14377	Ø 100	10x10 cm	50	108.40



5061.MA040.10.1	14378	Ø 40	10x10 cm	50	93.40
5061.MA050.10.1	14379	Ø 50	10x10 cm	50	93.40
5061.MA070.10.1	14380	Ø 70	10x10 cm	50	95.00
5061.MA100.10.1	14385	Ø 100	10x10 cm	50	98.40

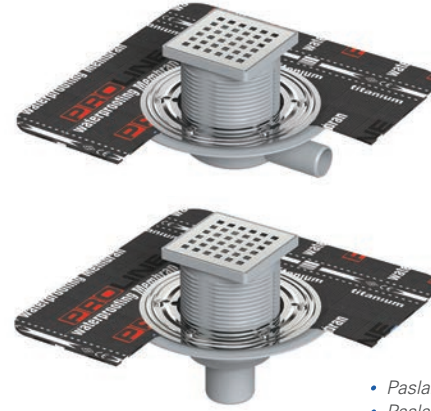

- Paslanmaz gövde
- Paslanmaz ızgara
- Sulu klepelili koku tutucu
- 210 mm bitüm membranlı

Ürün Kodu

Kısa Kod

Çıkış

Ölçü



Fiyat

210 MM 15x15 MEMBRANLI

5061.MY032.15.1	14376	Ø 32	15x15cm	50	111.70
5061.MY040.15.1	14381	Ø 40	15x15cm	50	113.40
5061.MY050.15.1	14382	Ø 50	15x15cm	50	113.40
5061.MY070.15.1	14383	Ø 70	15x15cm	50	116.70
5061.MY100.15.1	14384	Ø 100	15x15cm	50	120.00



5061.MA040.15.1	14386	Ø 40	15x15cm	50	110.00
5061.MA050.15.1	14388	Ø 50	15x15cm	50	110.00
5061.MA070.15.1	14390	Ø 70	15x15cm	50	113.40
5061.MA100.15.1	14392	Ø 100	15x15cm	50	116.10



- Paslanmaz gövde
- Paslanmaz ızgara
- Sulu klepelili koku tutucu
- 210 mm bitüm membranlı

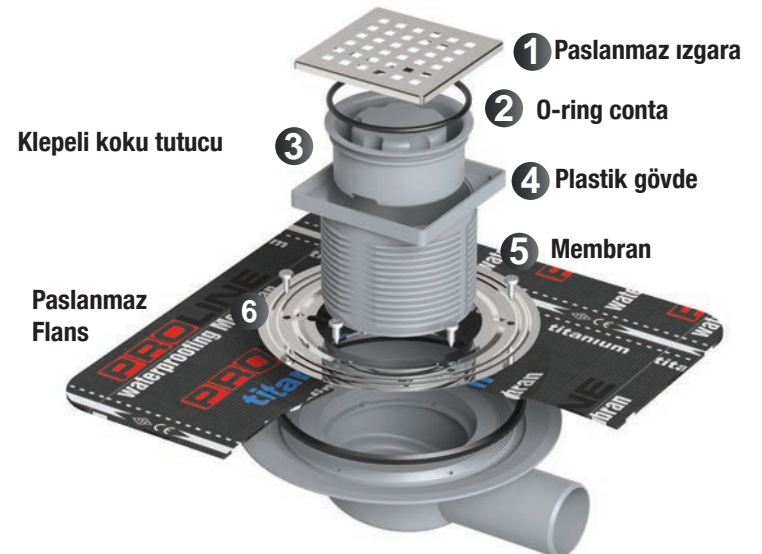
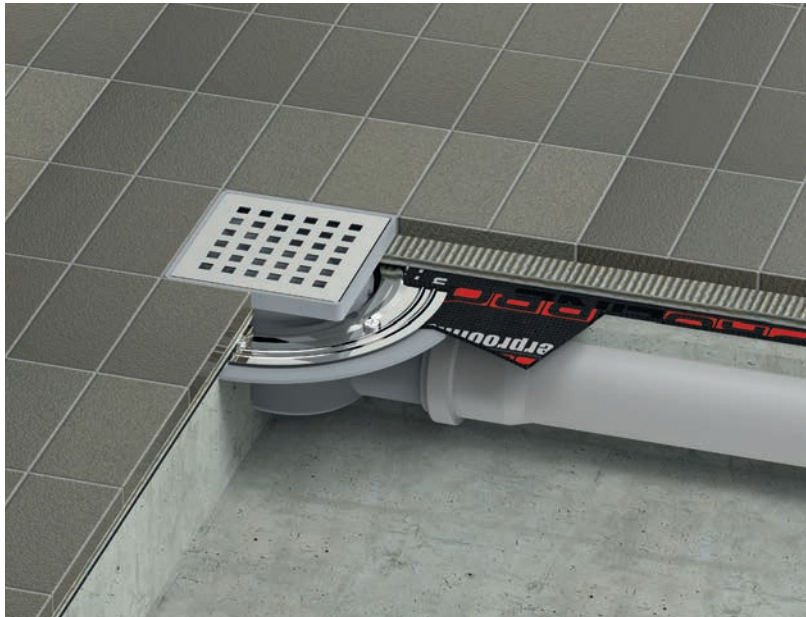

ÜRÜN KODU Kısa Kod Çap İKON FİYAT PARAPET

8001.0Y070.00.0	14387	Ø 70	30	25.00
8002.0Y100.00.0	14389	Ø 100	25	28.40

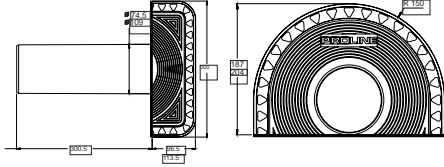

ÜRÜN KODU Kısa Kod Çap İKON FİYAT DİK İNİŞ

8001.0A070.00.0	14387	Ø 70	30	25.00
8002.0A100.00.0	14389	Ø 100	25	28.40

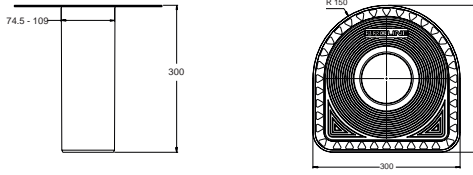

ÜRÜN KODU Kısa Kod Çap İKON FİYAT ÇATI HAVALANDIRMA

8003.0D070.00.0	14394	Ø 70	150	15.00
8004.0D100.00.0	14396	Ø 100	90	16.70

ÇATI HAVALADIRMA SET

8005.0D070.00.0	28907	Ø 70	150	53.40
8006.0D100.00.0	28908	Ø 100	90	56.70

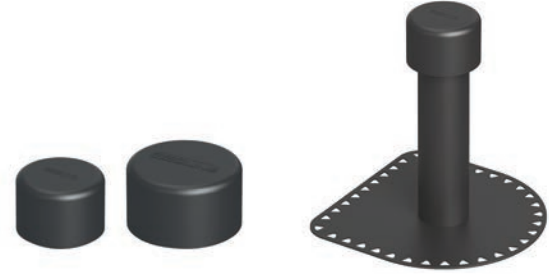
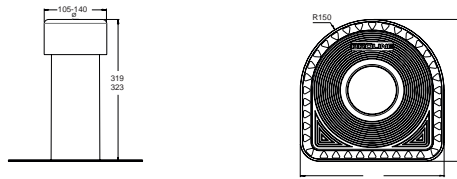

ÜRÜN KODU Kısa Kod Çap İKON FİYAT PARAPET ARA BAĞLARI

8201.0A070.10.0	14398	Ø 70	400	6.00
8202.0A100.10.0	14399	Ø 100	300	6.00

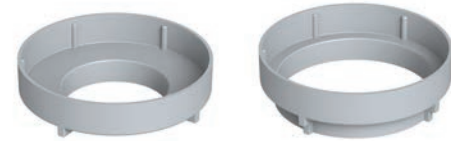
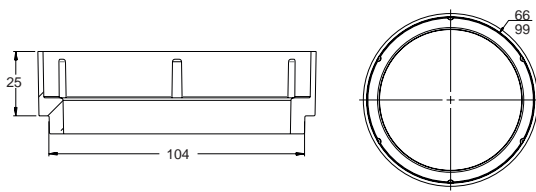

ÜRÜN KODU Kısa Kod Çap İKON FİYAT YAPRAK TUTUCU

9302.0D100.00.0	14395	Ø 70-100	175	12.70
-----------------	-------	----------	-----	-------

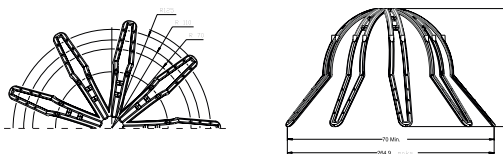

ÜRÜN KODU KISA KOD ÇIKIŞ ÖLÇÜ FİYAT PARAPET İKİZ GİDER 10x10

ÜRÜN KODU	KISA KOD	ÇIKIŞ	ÖLÇÜ	FİYAT
8101.0Y070.10.1	14400	Ø 70	10x10 cm	86.70
8101.0Y100.10.1	14402	Ø 100	10x10 cm	93.40

- 8001- Ø 70 Parapet + 5014.0Y050.10.1 Sifon Takımı
- 8002- Ø 100 Parapet + 5014.0Y070.10.1 Sifon Takımı

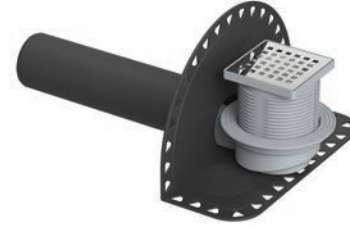

ÜRÜN KODU KISA KOD ÇIKIŞ ÖLÇÜ FİYAT PARAPET İKİZ GİDER 15x15

ÜRÜN KODU	KISA KOD	ÇIKIŞ	ÖLÇÜ	FİYAT
8101.0Y070.15.1	14403	Ø 70	15x15 cm	103.40
8101.0Y100.15.1	14405	Ø 100	15x15 cm	110.00

- 8001- Ø 70 Parapet + 5018.0Y050.15.1 Sifon Takımı
- 8002- Ø 100 Parapet + 5018.0Y070.15.1 Sifon Takımı



ÜRÜN KODU KISA KOD ÇAP ÖLÇÜ FİYAT DİK İNİŞ İKİZ GİDER 10x10

ÜRÜN KODU	KISA KOD	ÇAP	ÖLÇÜ	FİYAT
8102.0A070.10.1	14401	Ø 70	10x10 cm	72.50
8102.0A100.10.1	14404	Ø 100	10x10 cm	76.70

- 8001- Ø 70 Parapet + 8201 Ara Bağlantı + 5101 Sifon Üst Gövde
- 8002- Ø 100 Parapet + 8202 Ara Bağlantı + 5101 Sifon Üst Gövde



ÜRÜN KODU KISA KOD ÇAP ÖLÇÜ FİYAT DİK İNİŞ İKİZ GİDER 15x15

ÜRÜN KODU	KISA KOD	ÇAP	ÖLÇÜ	FİYAT
8102.0A070.15.1	14406	Ø 70	15x15 cm	90.00
8102.0A100.15.1	14407	Ø 100	15x15 cm	93.40

- 8001- Ø 70 Parapet + 8201 Ara Bağlantı + 5101 Sifon Üst Gövde
- 8002- Ø 100 Parapet + 8202 Ara Bağlantı + 5101 Sifon Üst Gövde



ÜRÜN KODU KISA KOD ÖLÇÜ FİYAT SHINGLE HAVALANDIRMA

ÜRÜN KODU	KISA KOD	ÖLÇÜ	FİYAT
8010.YD080.00.S	14408	34x44x8,5 cm	41.70
8010.YD080.00.Y	14411	34x44x8,5 cm	41.70
8010.YD080.00.K	14412	34x44x8,5 cm	41.70

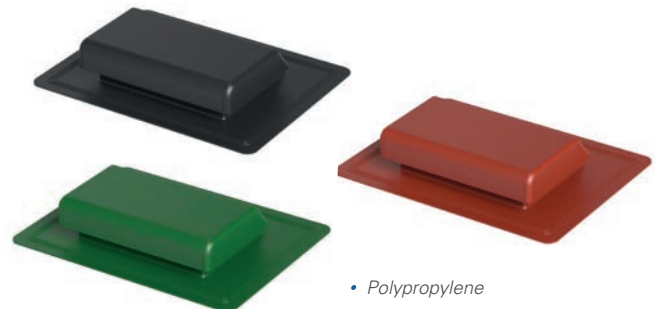

- Polypropylene

Ürünlerimiz  göre üretilmiştir.



MODÜLER REZERVASYON SİSTEMİ

Pvc atıksu borularının,duvar ve katlar arası hatların sorunsuz geçişi ve sürekliliğini sağlamak,ıslak zeminlerde oluşabilecek kaçak sorunlarını gider tesisatına taşımak işçilik,montaj,zaman ve maliyet faktörlerinin minimum seviyeye indirilmesini sağlamak için geliştirilmiş membran ve sürme yalıtıma uyumlu modüler rezervasyon sistemidir.



Klasik sistem;

Önceden oluşmuş rezervasyon açıklıkları beton dolgu ve izolasyondan sonra gider borularının montajı esnasında izolasyon hasar görmekte ve konutun kullanımı esnasında sızıntı olmaktadır. Bu sistemden mümkün olduğunca kaçınılmalıdır.

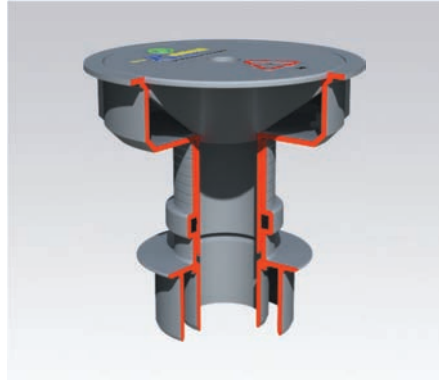

M.Rezervasyon sistemi;

Gider rezervasyonu kullanımı sayesinde,ıslak hacimlerde mükemmel su geçirmezlik performansı sağlamak ve bu tür kaçak sorunları önemli ölçüde minimize edilebilmektedir.Gider rezervasyonu kullanmakla ıslak hacimlerinizdeki sızıntı ve sorunlarınız artık geçmişte bırakmış olacaksınız.Gider rezervasyonu donatı aşamasında kalıba montajı yapılmakta ve dökülen betonun içinde sabit kalmaktadır.



Maximum düzeyde koruma.

Düşük maliyet.

Zamandan tasarruf.

Saniyeler içinde yapılabilen uygulama ve sonra sırada gider borularının montajı.Kalıp sistemi üzerinde rezervasyon boşlukları bırakmadan,süzgeç montajından sonra dolgu ve izolasyona ihtiyaç duymadan,karotla delik delme ve dolgu uygulaması yapmaya gerek duymadan sıfır hata ile montajı uygulanabilmektedir.Mevcut sisteme göre çok pratik ve kullanılabilirliği son derece yüksek bir üründür.

NEDEN ?

Islak hacim alanları için
komple
Rezervasyon sistemi



Günlük yaşamımızda zamanımızın önemli bir bölümünü konutlarımızın içinde geçirmekteyiz. Zamanla ıslak hacimlerde oluşabilecek sorunları gider rezervasyonu ile tamamen yok etmek amacı ile uzun bir çalışma ve arge'nin sonunda bu ürünü oluşturdu ve üretme fikri doğmuştur.

Islak hacim alanlarında ,banyo ve tuvaletlerde genellikle inşa aşamasında yetersiz veya iyi uygulanmamış izolasyon,vibre edilmemiş kılcal çatlaklı beton , kalitesiz işçilik, konutun kullanımı esnasında ıslak hacimlerde kullanılan kimyasallardan veya işçilik hataları vb. nedenlerden dolayı zamanla su sızıntıları olmaktadır.ıslak hacim,tuvalet ve banyo giderlerindeki su sızıntıları genel olarak ortak sorundur ve bu tür sorunları konutların kullanımı esnasında çözmek maliyeti yüksek bedellere neden olmaktadır. Bu sistem ıslak hacimlerde oluşabilecek her türlü sorunu minimize etmek ve gider tesisatına zahmetsizce müdahale edebilmeyi sağlamaktadır.



Klozet



Lavabo



Küvet



Duş
Teknesi



Balkon



Teras



Süzgeç



Lineer
Kanal

UYGULAMA TESTLERİ

Sorunsuz yaşam alanları için;
Sizde modüler rezervasyon sistemini tercih edin..

Birçok prestijli projede yapılan test ve çalışmalarında iyi vibre edilmiş betonda izolasyon uygulaması yapılmadan %90 olumlu sonuç alınmış ve kullanılabilir olduğunu kanıtlamıştır. Su geçirmezliğin iyileştirilmesi ve oluşabilecek sorunları minimize etmek için standartlara uyulmasını önemle tavsiye ederiz.

Gider (Kat Geçiş) rezervasyonu; uygulama ve sızdırmazlık testleri "KİPTAŞ" mühendisleri ile ortaklaşa yürütülen çalışma ile yapılmıştır.

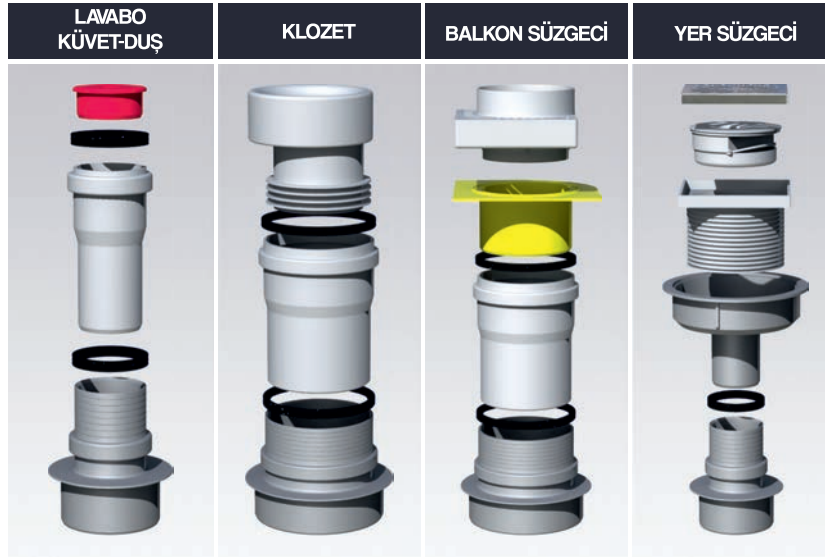

KURULUM NOTLARI

Konutlarda yaygın olarak ;

- Banyo süzgeci
 - Köşe balkon süzgeci
 - Klozet
 - Lavabo
 - Duş teknesi
 - Küvet
 - Teras
- ve boru rezervasyonun ihtiyaç duyulduğu her alanda sorunsuz kullanılmaktadır.

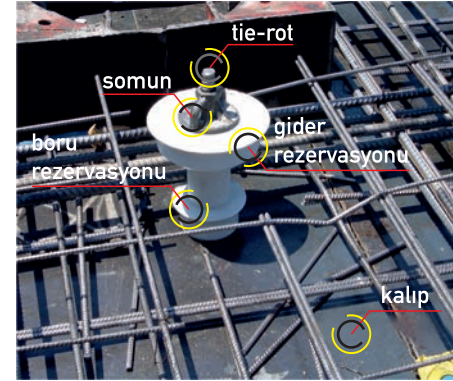

Boru rezervasyon elemanları duvar, zemin, tavan, yapısal destekler ve rezervasyonun ihtiyaç duyduğu alanlar dahil olmak üzere, beton döküldükten sonra dairesel boru montaj boşluklarının oluşması için kullanılır.

Kurulum Elemanları

- 1 - M14 Somun
- 2 - Tie-rot
- 3 - Tie-rot Somunu
- 4 - Kat geçiş rezervasyonu
- 5 - Rezervasyon Contası
- 6 - Gider Süzgeci Rezervasyonu
- 7 - Montaj Kapağı
- 8 - Gider Süzgeci
- 9 - Koku Fermatürü
- 10 - Paslanmaz Izgara

Ön Hazırlık ve Montaj Aşamaları

Bakınız Sayfa 4
Ürün detay ve montaj uygulamaları için animasyon cd'sini lütfen talep ediniz.

Kurulum aşamaları

- 1 - R.Contası kat geçiş rezervasyonuna takılır.
- 2 - Gider Rezervasyonu kat geçiş rezervasyonu ile birleştirilir.
- 3 - Tie-rot Kalıba kaynatılan somuna sabitlenir.
- 4 - Beton zeminin yüksekliğine göre rezervasyonun boyu kesilerek ayarlanır.
- 5 - Modüler birleşik rezervasyonlar tie-rot montaj kapağı ile birlikte yerleştirilir.
- 6 - Son olarak tie-rot somunu takılarak sabitleme sağlanır.

Uygulanabilirlik

Montajın uygulanması yalnızca 1 dakikadır.

REZERVASYON MONTAJ DETAYLARI

Kat geiř rezervasyonları iletken olmayan, yüksek darbeye dayanıklı polipropilen malzemeden üretilmiř, hafif ve motaj iřçiliđi son derece kolay yüksekliđi ayarlanabilen modüler üründür.

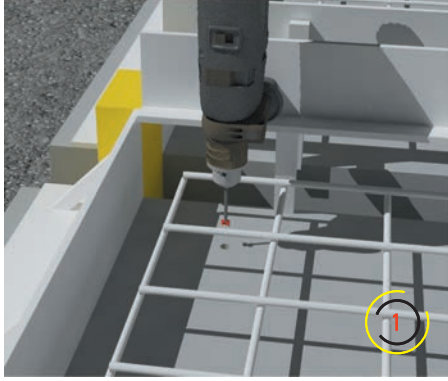

Tünel kalıp sisteminde projede belirlenen noktalar M15 matkapla delinir.



Pullu somun kalıp sisteminin alt kısmına, delinen deliđin merkezine kaynakla sabitlenir. Bu iřlem tünel kalıp sisteminde yalnızca bir kez yapılmak tadır.

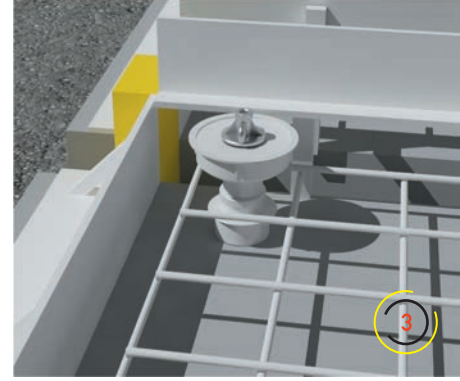

Donatı demirlerinin döřenmesinin ardından Rezer vasyon sistemine ait parçalar tie-rot yardımıyla kalıp sistemine sabitlemesi sađlanır.Devamında beton dökme iřlemi gerekleřerek sistem kullanıma hazır hale gelir.

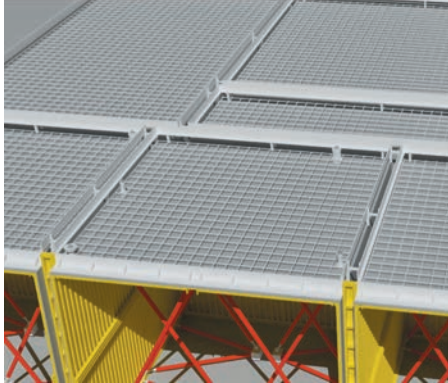

Beton dökümü gerekleřiř kalıplarının sökülmesinin ardından gider tesisatı rezervasyonu hazırdır.Derhal montaj uygulaması yapılabilir.

MODÜLER REZERVASYON SİSTEMLERİ

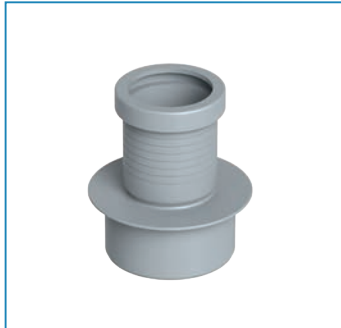

KOD 0101001100050
25561
ÜRÜN ADI KAT GEÇİŐ REZERVASYONU
ALT PARÇA ø 50mm

FİYAT 16.70



KOD 0103001100250
25562
ÜRÜN ADI GİDER SÜZGEÇİ
REZERVASYONU ø 50mm

FİYAT 13.40

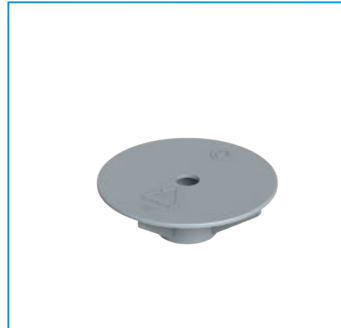

KOD 0104001000010
25564
ÜRÜN ADI KORUMA KAPAđI

FİYAT 17.85

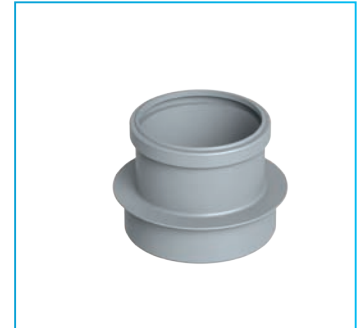

KOD 0102001100100
25565
ÜRÜN ADI KAT GEÇİŐ
REZERVASYONU ø 100mm

FİYAT 20.00

SİSTEM KARŞILAŞTIRMASI

Rezervasyon Adaptörü,
TSE TS 275-1 EN 1329-1 normunda belirtilen
pvc atıksu borularına ait ölçüler esas alınarak
standartlara uygun ölçülendirme yapılmıştır.

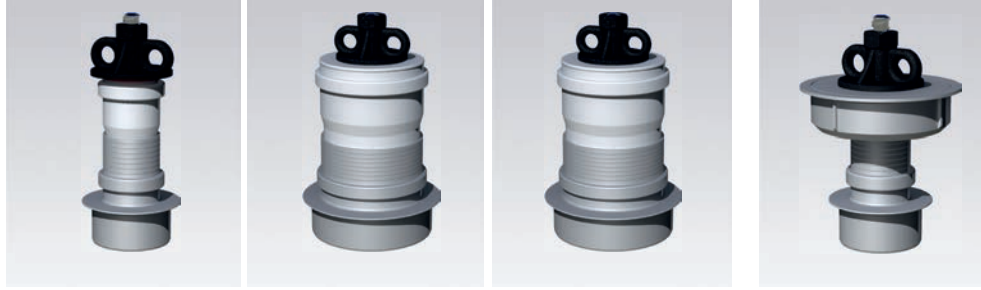

SİSTEMLER	LAVABO-KÜVET-DUŞ	KLOZET	BALKON SÜZGEÇİ	YER SÜZGEÇİ
ÜRÜN VERİMLİLİĞİ			MODÜLER R.SİSTEMİ	KALIP REZERVASYON
Kıarak rezervasyon oluşturmak			Yok	Var
Kalıp ile rezervasyon oluşturmak			Yok	Var
Rezervasyonda çevre boşluğu doldurma			Yok	Var
İzolasyonda hasar görme			Yok	Var
Kırım enasında betonda çatlak oluşma riski			Yok	Var
*Sürme veya membran izolasyon uygulama ihtiyacı			Yok	Var
Karotla delik delme işlemi			Yok	Var
Betonarme kalınlığına göre boy ayarlanabilme			Var	Yok
Süzgeç ve gider malzemelerin yardımcı ürünlere ihtiyacı			Yok	Var
Rezervasyon çevre boşluğundan su sızma problemi			Yok	Var
Alt toplama montajı esnasında izolasyonun hasar görme riski			Yok	Var
Stok maliyeti			Yok	Var
Montaj Kolaylığı			Var	Yok
Estetik görüntü			Var	Yok
Düşük maliyet			Var	Yok
Sisteme müdahale kolaylığı			Var	Yok

* (iyi vibre edilmiş beton için geçerlidir.)

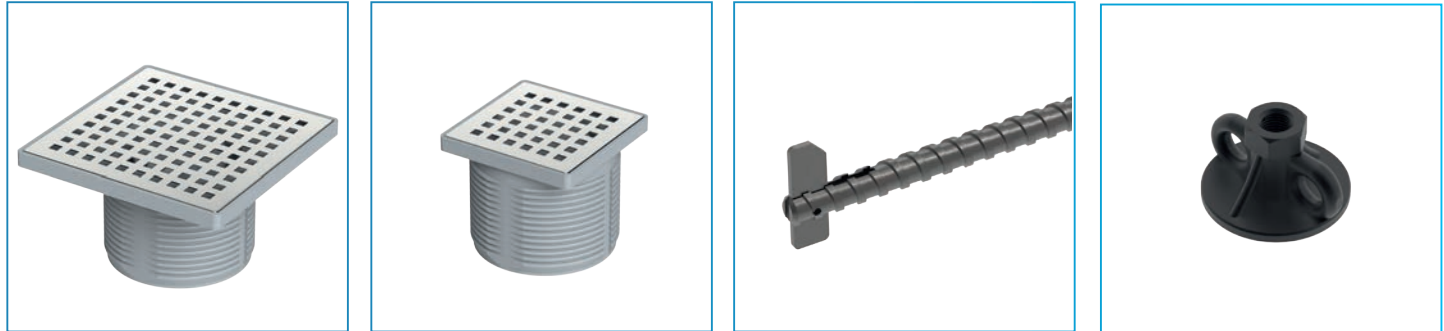

KOD 5107 A.Ç. Line
14200
ÜRÜN ADI 15x15 SİFON ÜST GÖVDE

KOD 5101 A.Ç. Line
14198
ÜRÜN ADI 10x10 SİFON ÜST GÖVDE

KOD 0120250103250
25566
ÜRÜN ADI TIE-ROT

KOD 0121000103251
25567
ÜRÜN ADI TIE-ROT SOMUN

FİYAT 58.40

FİYAT 44.40

FİYAT 35.00

FİYAT 36.70

KANAL OLUĞU 100x500 mm

Ürün Kodu	Kısa Kod	Ölçü	Yükseklik		Fiyat
7010.05005Y.0.0	13659	100x500 mm	50 mm	40	23.40
7011.05005A.0.0	13660	100x500 mm A.Ç.	50 mm	32	24.40



• Plastik gövde

PLASTİK KANAL IZGARASI 100x500mm

Ürün Kodu	Kısa Kod	Ölçü	Yükseklik		Fiyat
7110.050120.0.0	13653	100x500 mm	-	40	19.00



• Plastik gövde

PASLANMAZ KANAL IZGARASI 100x500mm

Ürün Kodu	Kısa Kod	Ölçü	Kalite	Desen	Fiyat
2110.05012P.304.2	13745	100x500 mm	S.S.304	Kare	96.70
2110.10012P.304.2	13780	100x1000 mm	S.S.304	Kare	193.40

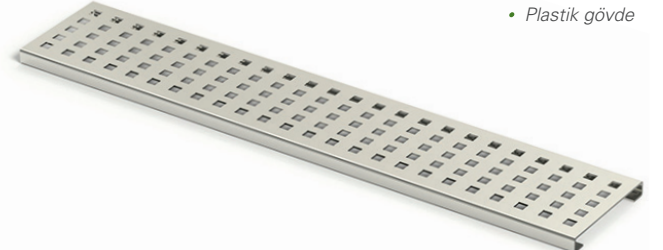

• Paslanmaz Izgara

2110.05012G.430.1	13749	100x500 mm	Galvaniz	Kare	48.00
2110.05012G.430.2	13784	100x1000 mm	Galvaniz	Kare	83.00

KANAL TAPASI 100 mm

Ürün Kodu	Kısa Kod	Ölçü	Yükseklik		Fiyat
7210.00050Y.0.0	13667	80x63 mm	-	150	5.80



• Plastik gövde
• Ø 32 çıkış

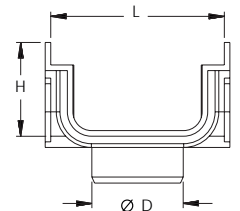
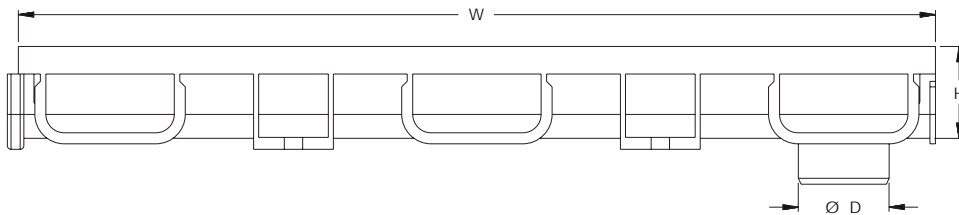
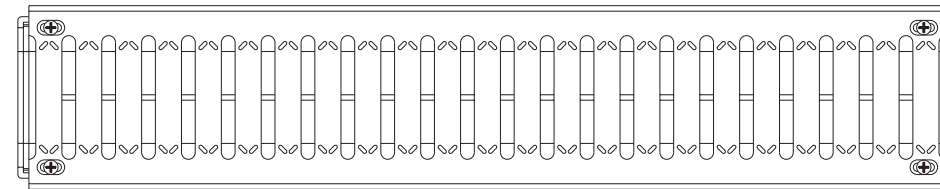
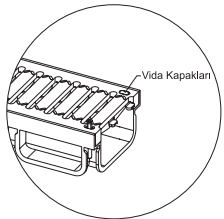
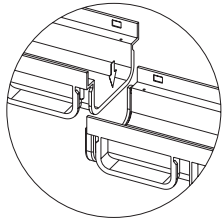
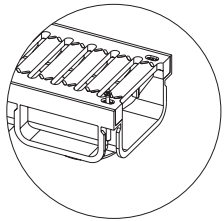

IZGARA DESEN SEÇENEKLERİ



PLASTİK

- PP
- AISI 304
- AISI 430
- Galvaniz
- Sfero Döküm



KARE

- AISI 304
- AISI 430
- Galvaniz

Ürünlerimiz  göre üretilmiştir.

KANAL OLUĞU 100x500 mm

Ürün Kodu	Kısa Kod	Ölçü	Yükseklik		Fiyat
-----------	----------	------	-----------	---	-------

7010.05005Y.0.S	26863	100x500 mm	50 mm	40	21.70
-----------------	-------	------------	-------	----	-------

7011.05005A.0.S	26864	100x500 mm A.Ç.	50 mm	32	22.70
-----------------	-------	-----------------	-------	----	-------



PLASTİK KANAL IZGARASI 100x500mm

Ürün Kodu	Kısa Kod	Ölçü	Yükseklik		Fiyat
-----------	----------	------	-----------	---	-------

7110.050120.0.S	26865	100x500 mm	-	40	18.00
-----------------	-------	------------	---	----	-------



PASLANMAZ KANAL IZGARASI 100x500mm

Ürün Kodu	Kısa Kod	Ölçü	Kalite	Desen	Fiyat
-----------	----------	------	--------	-------	-------

2110.05012P.304.2	13745	100x500 mm	S.S.304	Kare	96.70
-------------------	-------	------------	---------	------	-------

2110.10012P.304.2	13780	100x1000 mm	S.S.304	Kare	193.40
-------------------	-------	-------------	---------	------	--------

2110.05012G.430.1	13749	100x500 mm	Galvaniz	Kare	48.00
-------------------	-------	------------	----------	------	-------

2110.05012G.430.2	13784	100x1000 mm	Galvaniz	Kare	83.00
-------------------	-------	-------------	----------	------	-------



KANAL TAPASI 100 mm

Ürün Kodu	Kısa Kod	Ölçü	Yükseklik		Fiyat
-----------	----------	------	-----------	---	-------

7210.00050Y.0.S	26866	80x63 mm	-	150	5.40
-----------------	-------	----------	---	-----	------



• Plastik gövde

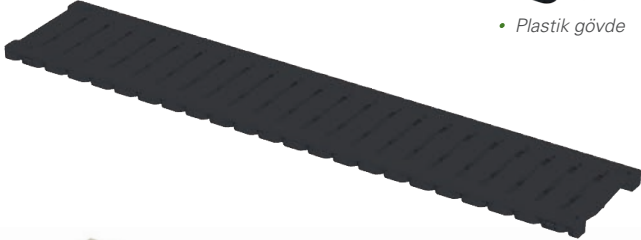

• Plastik gövde



• Paslanmaz Izgara



• Plastik gövde
• Ø 32 çıkış

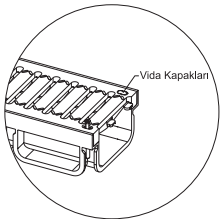
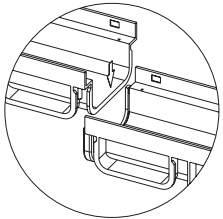
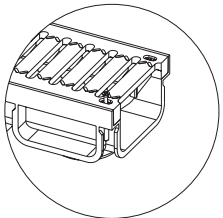

Vida Kapakları

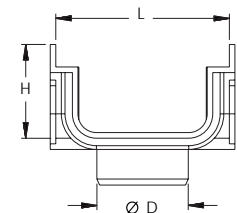
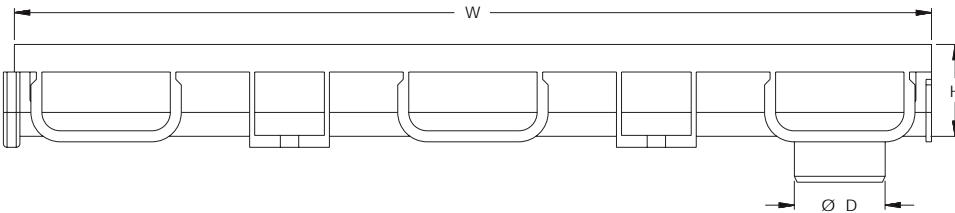
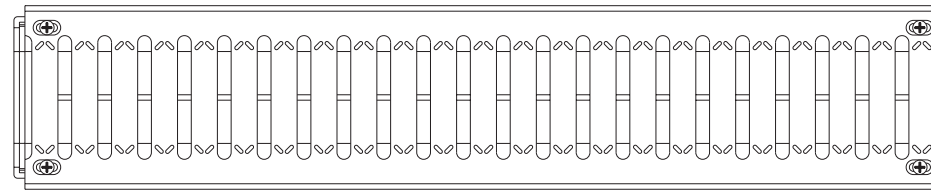

IZGARA DESEN SEÇENEKLERİ



PLASTİK

- PP
- AISI 304
- AISI 430
- Galvaniz
- Sfero Döküm



KARE

- AISI 304
- AISI 430
- Galvaniz

Ürünlerimiz  göre üretilmiştir.

DRENAJ KANALLARI

MAXIFLOW

KANAL OLUĞU 130x500 mm

Ürün Kodu	Kısa Kod	Ölçü	Yükseklik	Çıkış	Fiyat	
7013.05008Y.0.0	13661	130x500 mm	75 mm	-	40	28.40
7014.05008A.0.0	13662	130x500 mm A.Ç.	75 mm	Ø 49.5 / 74.5	32	29.40

PLASTİK KANAL IZGARASI 130x500mm

Ürün Kodu	Kısa Kod	Ölçü	Yükseklik	Fiyat	
7113.050200.0.0	13655	130x500 mm	-	1	25.80

PASLANMAZ KANAL IZGARASI 130x500mm

Ürün Kodu	Kısa Kod	Ölçü	Kalite	Desen	Fiyat
2113.05020P304.2	13811	130x500 mm	S.S.304	Kare	126.70
2113.05020P304.4	13788	130x500 mm	S.S.304	Standart	113.40
2113.10020P304.2	13833	130x1000 mm	S.S.304	Kare	260.00
2113.10020P304.4	13821	130x1000 mm	S.S.304	Standart	223.40
2113.05020P430.4	13797	130x500 mm	Galvaniz	Standart	63.00
2113.10021P430.4	13825	130x1000 mm	Galvaniz	Standart	113.00

SFERO DÖKÜM KANAL IZGARASI 130x500mm

Ürün Kodu	Kısa Kod	Ölçü	Kalite	Desen	Fiyat
2113.05020D.000.4	18172	130x500 mm	Sfero Döküm	Standart	183.40

KANAL TAPASI 130 mm

Ürün Kodu	Kısa Kod	Ölçü	Açıklama	Fiyat	
7212.00070Y.0.0	13668	125x75 mm	Erkek tapa çıkışlı	150	10.00
7227.00070Y.0.0	13669	125x75 mm	Dişi tapa	150	10.00
7228.00070Y.0.0	13670	125x75 mm	Dişi tapa çıkışlı	150	10.00



• Polypropylene



• Polypropylene



• Paslanmaz



• Pik Döküm

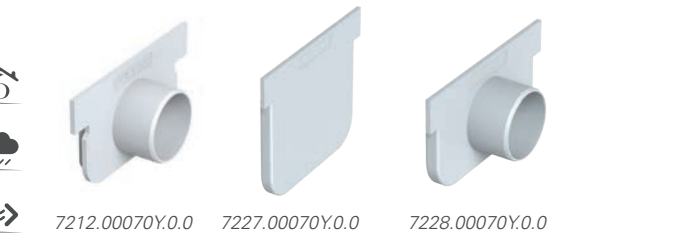

7212.00070Y.0.0 7227.00070Y.0.0 7228.00070Y.0.0

• Polypropylene
• Ø 50 çıkış

Ürünlerimiz  göre üretilmiştir.





KANAL OLUĞU 130x500 mm

Ürün Kodu	Kısa Kod	Ölçü	Yükseklik	Çıkış	Fiyat
7013.05008Y.0.S	25118	130x500 mm	75 mm	-	40 23.40
7014.05008A.0.S	25119	130x500 mm A.Ç.	75 mm	Ø 49.5 / 74.5	32 26.70



• Polypropylene

PLASTİK KANAL IZGARASI 130x500mm

Ürün Kodu	Kısa Kod	Ölçü	Yükseklik	Fiyat
7113.050200.0.S	25120	130x500 mm	-	40 22.70



7212.00070Y.0.S

7227.00070Y.0.S

7228.00070Y.0.S

• Polypropylene
• Ø 50 çıkış

KANAL TAPASI 130 mm

Ürün Kodu	Kısa Kod	Ölçü	Açıklama	Fiyat
7212.00070Y.0.S	26104	125x75 mm	Erkek tapa çıkışlı	150 8.40
7227.00070Y.0.S	27108	125x75 mm	Dişi tapa	150 8.40
7228.00070Y.0.S	27109	125x75 mm	Dişi tapa çıkışlı	150 8.40

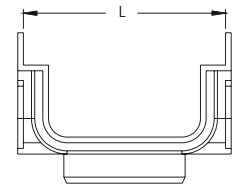
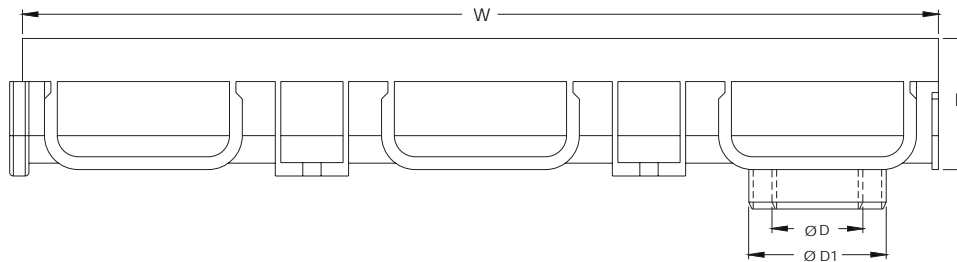
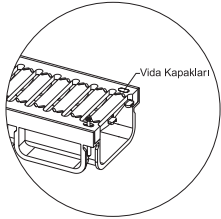
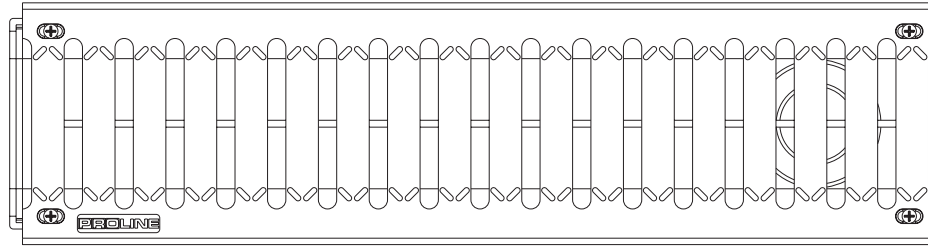
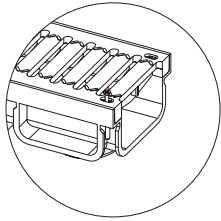

ÜRÜN KODU	W	L	H	Ø D	Ø D1
7013.05008Y.0.0	500	125	75	-	-
7014.05008A.0.0	500	125	75	49.5	74.5

KANAL OLUĞU 130x1000 mm

Ürün Kodu	Kısa Kod	Ölçü	Yükseklik	Çıkış	İkna	Fiyat
7015.10010Y.0.0	13663	130x1000 mm	100 mm	-	20	70.00
7016.10010A.0.0	13664	130x1000mmA.Ç.	100 mm	Ø 49.5 / 74.5	16	73.40

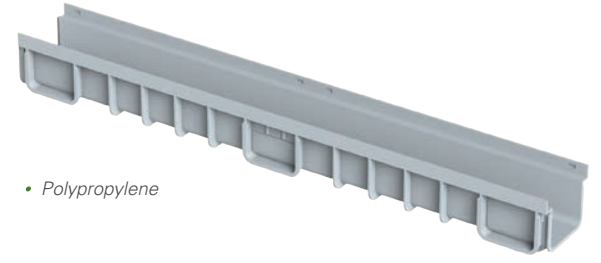

• Polypropylene

PLASTİK KANAL IZGARASI 130x500mm

Ürün Kodu	Kısa Kod	Ölçü	Yükseklik	İkna	Fiyat
7113.050200.0.0	13655	130x500 mm	-	40	25.80



• Polypropylene

KANAL TAPASI 130 mm

Ürün Kodu	Kısa Kod	Ölçü	Açıklama	İkna	Fiyat
7213.00100Y.0.0	13671	125x100 mm	Erkek tapa çıkışlı	150	11.70
7230.00100Y.0.0	13672	125x100 mm	Dişi tapa	150	11.70
7231.00100Y.0.0	13673	125x100 mm	Dişi tapa çıkışlı	150	11.70

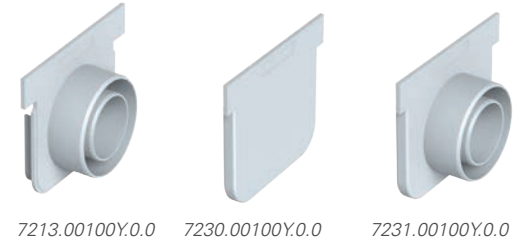

• Polypropylene
• Ø 50 ve 70 çıkış

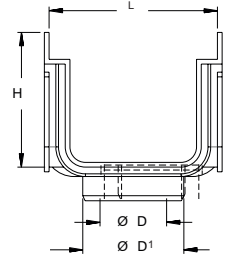
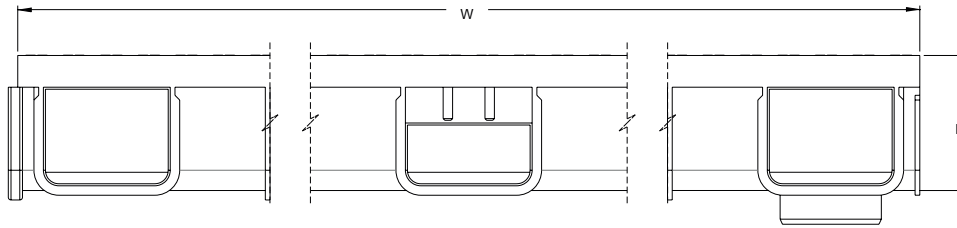
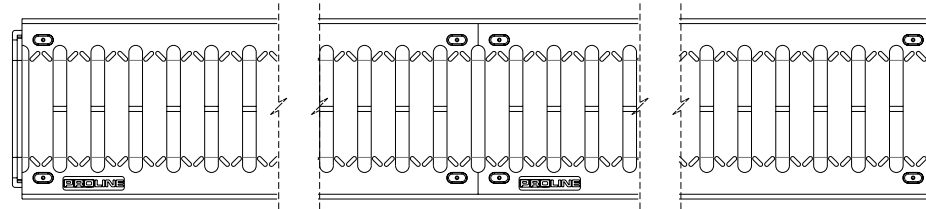
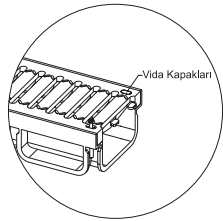
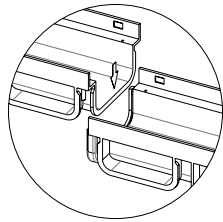
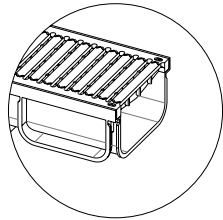

IZGARA DESEN SEÇENEKLERİ

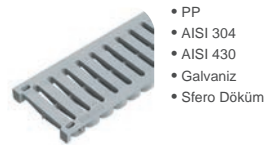

PLASTİK

- PP
- AISI 304
- AISI 430
- Galvaniz
- Sfero Döküm



KARE

- AISI 304
- AISI 430
- Galvaniz

Ürünlerimiz  göre üretilmiştir.

ÜRÜN KODU	W	L	H	Ø D	Ø D1
7015.10010Y.0.0	1000	125	75	-	-
7016.10010A.0.0	1000	125	75	49.5	74.5





KANAL OLUĞU 130x1000 mm

Ürün Kodu	Kısa Kod	Ölçü	Yükseklik	Çıkış	Fiyat
7015.10010Y.0.S	27104	130x1000 mm	100 mm	-	20 53.40
7016.10010A.0.S	27105	130x1000mmA.Ç.	100 mm	Ø 49.5 / 74.5	16 56.70

PLASTİK KANAL IZGARASI 130x500mm

Ürün Kodu	Kısa Kod	Ölçü	Yükseklik	Fiyat
7113.050200.0.S	25120	130x500 mm	-	40 22.70

KANAL TAPASI 130 mm

Ürün Kodu	Kısa Kod	Ölçü	Açıklama	Fiyat
7213.00100Y.0.S	27112	125x100 mm	Erkek tapa çıkışlı	150 10.00
7230.00100Y.0.S	27110	125x100 mm	Dişi tapa	150 10.00
7231.00100Y.0.S	27111	125x100 mm	Dişi tapa çıkışlı	150 10.00



• Polypropylene



• Polypropylene

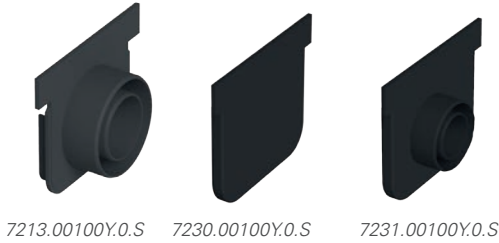

7213.00100Y.0.S 7230.00100Y.0.S 7231.00100Y.0.S

• Polypropylene
• Ø 50 ve 70 çıkış

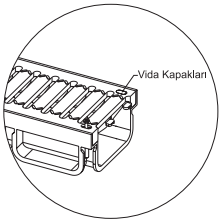
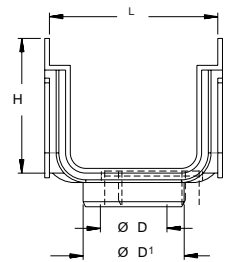
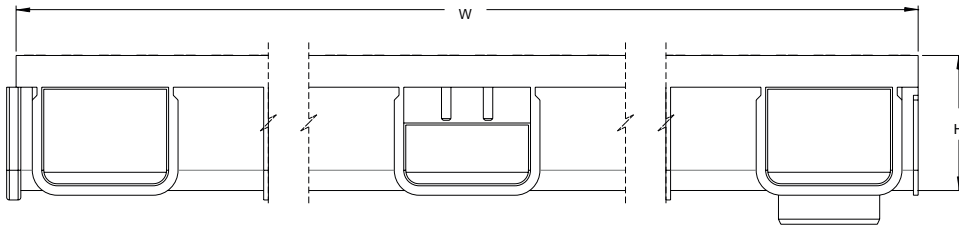
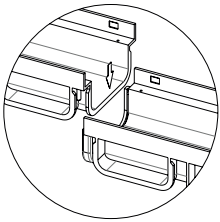
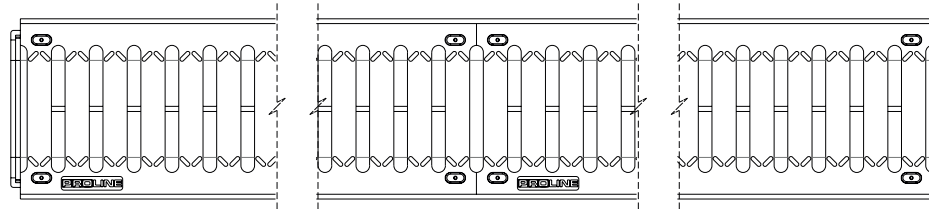
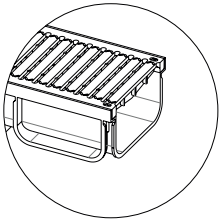

Vida Kapakları

IZGARA DESEN SEÇENEKLERİ



PLASTİK

- PP
- AISI 304
- AISI 430
- Galvaniz
- Sfero Döküm



KARE

- AISI 304
- AISI 430
- Galvaniz

Ürünlerimiz  göre üretilmiştir.

ÜRÜN KODU	W	L	H	Ø D	Ø D1
7015.10010Y.0.0	1000	125	75	-	-
7016.10010A.0.0	1000	125	75	49.5	74.5



DRENAJ KANALLARI

MAXIFLOW

KANAL OLUĞU 200x500 mm

Ürün Kodu	Kısa Kod	Ölçü	Yükseklik	Çıkış	İkna	Fiyat
7020.05013Y.0.0	13665	200x500 mm	120 mm	-	20	53.40
7021.05013A.0.0	13666	200x500 mm A.Ç.	120 mm	Ø 74.5 / 109.5	18	56.70

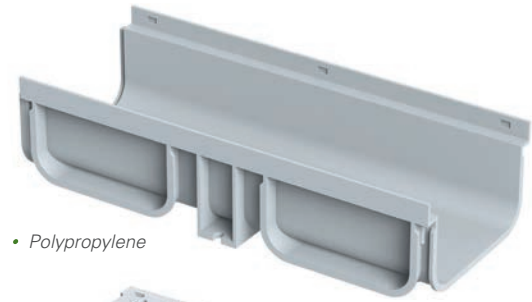

• Polypropylene



• Polypropylene

PLASTİK KANAL IZGARASI 200x500 mm

Ürün Kodu	Kısa Kod	Ölçü	Yükseklik	İkna	Fiyat
7120.050200.0.0	13657	200x500 mm	-	20	46.70

PASLANMAZ KANAL IZGARASI 200x500mm

Ürün Kodu	Kısa Kod	Ölçü	Kalite	Desen	Fiyat
2120.05021P304.2	13861	200x500 mm	S.S.304	Kare	253.40
2120.05021P304.3	13851	200x500 mm	S.S.304	Çizgi	253.40
2120.05021P304.4	13840	200x500 mm	S.S.304	Standart	250.00
2120.05021P430.4	13849	200x500 mm	GALVANİZ	Standart	190.00



• Paslanmaz

SFERO DÖKÜM KANAL IZGARASI 200x500mm

Ürün Kodu	Kısa Kod	Ölçü	Kalite	Desen	Fiyat
2120.05020D.000.4	18181	200x500 mm	Sfero Döküm	Standart	313.40



• Pük Döküm

KANAL TAPASI 200 mm

Ürün Kodu	Kısa Kod	Ölçü	Yükseklik	İkna	Fiyat
7220.00120Y.0.0	13674	200x500 mm	-	150	11.70



• Polypropylene
• Ø 70 çıkış

IZGARA DESEN SEÇENEKLERİ



PLASTİK

- PP
- AISI 304
- AISI 430
- Galvaniz
- Sfero Döküm



KARE

- AISI 304
- AISI 430
- Galvaniz

ÜRÜN KODU	W	L	H	Ø D	Ø D1
7020.05013Y.0.0	500	200	120	-	-
7021.05013A.0.0	500	200	120	74.5	109.5

Ürünlerimiz göre üretilmiştir.





KANAL OLUĞU 200x500 mm

Ürün Kodu	Kısa Kod	Ölçü	Yükseklik	Çıkış	Fiyat
7020.05013Y.0.S	26920	200x500 mm	120 mm	-	43.40
7021.05013A.0.S	26921	200x500 mm A.Ç.	120 mm	Ø 74.5 / 109.5	45.00



• Polypropylene

PLASTİK KANAL IZGARASI 200x500 mm

Ürün Kodu	Kısa Kod	Ölçü	Yükseklik	Fiyat
7120.050200.0.S	26922	200x500 mm	-	36.70

• Polypropylene



KANAL TAPASI 200 mm

Ürün Kodu	Kısa Kod	Ölçü	Yükseklik	Fiyat
7220.00120Y.0.S	27083	200x500 mm	-	10.00

• Polypropylene
• Ø 70 çıkış

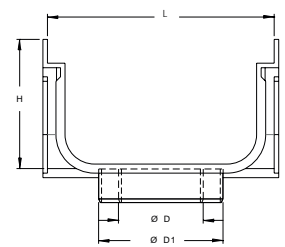
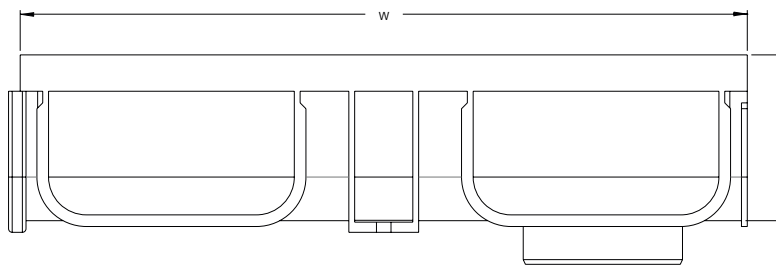
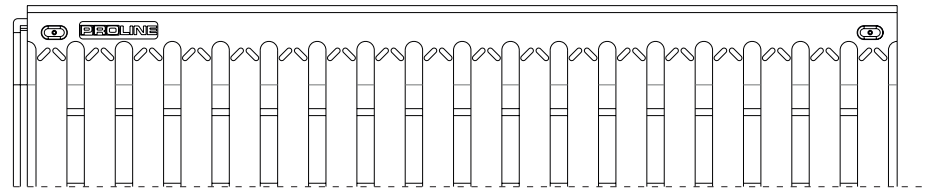
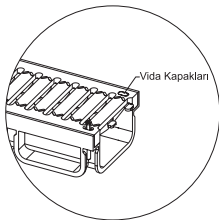
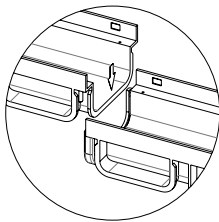
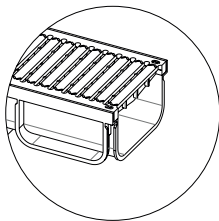

IZGARA DESEN SEÇENEKLERİ

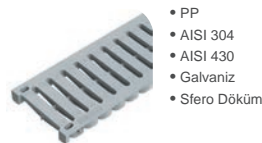

PLASTİK

- PP
- AISI 304
- AISI 430
- Galvaniz
- Sfero Döküm



KARE

- AISI 304
- AISI 430
- Galvaniz



YUVARLAK

- AISI 304
- AISI 430
- Galvaniz

ÜRÜN KODU	W	L	H	Ø D	Ø D1
7020.05013Y.0.0	500	200	120	-	-
7021.05013A.0.0	500	200	120	74.5	109.5



Ürünlerimiz  göre üretilmiştir.

POLİMER KANAL 100x1000 mm

Ürün Kodu	Kısa Kod	Ölçü	Yükseklik		Fiyat
2010.100K00.060.S	13675	100x1000 mm	60 mm	1	276.70
2010.100K00.080.S	13676	100x1000 mm	80 mm	1	290.00

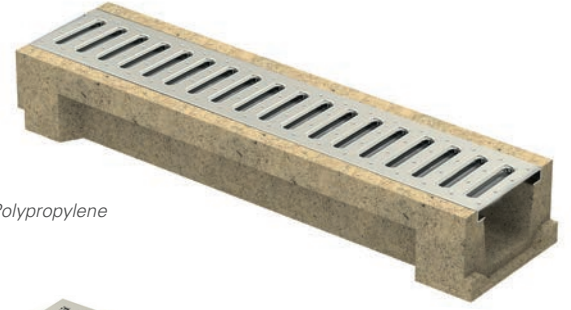

• Polypropylene

KANAL IZGARASI 100 mm

Ürün Kodu	Kısa Kod	Ölçü	Kalite	Desen	Fiyat
2110.05012P304.2	13745	100x500 mm	S.S.304	Kare	96.70
2110.10012P304.2	13780	100x1000 mm	S.S.304	Kare	193.40



• Paslanmaz

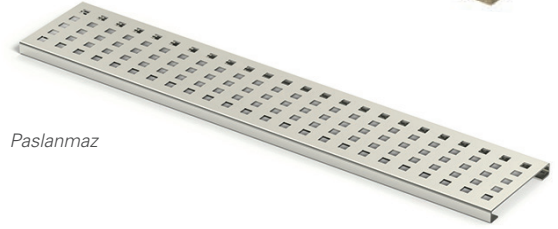

* Alt Çıkışlar İsteğe Bağlıdır. Sipariş Esnasında Belirtiniz.
* Görseldeki Izgara birim fiyata dahil değildir.

KANAL TAPASI 100 mm

Ürün Kodu	Kısa Kod	Ölçü	Yükseklik		Fiyat
2010.000T00.060.S	13709	100x60 mm	60 mm	1	40.00
2010.000T00.080.S	13710	100x80 mm	80 mm	1	40.00



• Polypropylene

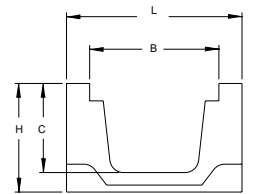
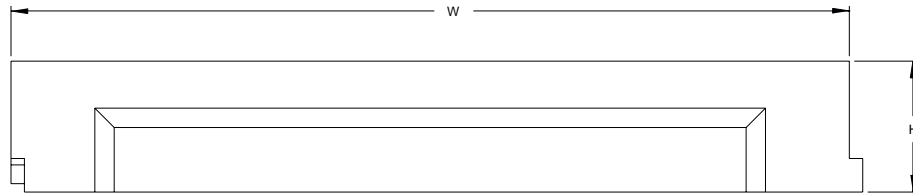
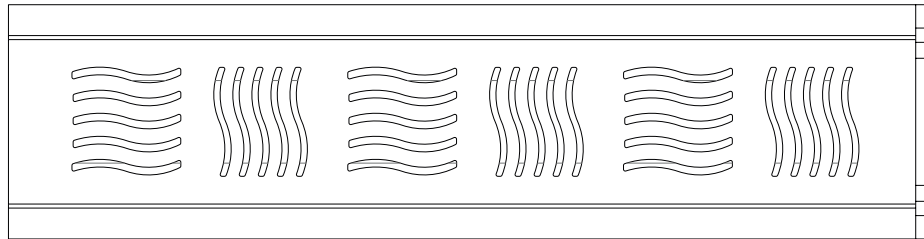
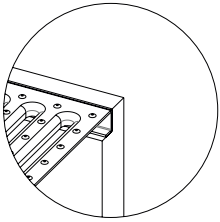

ÜRÜN KODU	W	L	H	Ø D	Ø D1
7020.05013Y.0.0	500	200	120	-	-
7021.05013A.0.0	500	200	120	74.5	109.5

IZGARA DESEN SEÇENEKLERİ



• AISI 304
• AISI 430
• Galvaniz

KARE



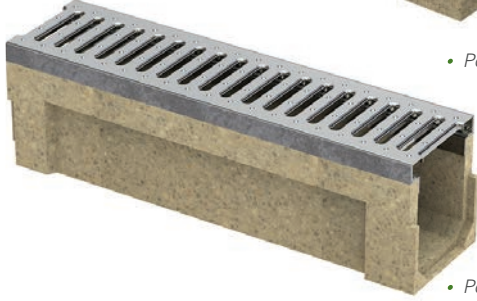

• Polypropylene

• Polypropylene

* Alt Çıkışlar İsteğe Bağlıdır. Sipariş Esnasında Belirtiniz.
* Görseldeki Izgara birim fiyata dahil değildir.



• Polypropylene



POLİMER KANAL 130x1000 mm

Ürün Kodu	Kısa Kod	Ölçü	Yükseklik		Fiyat
2013.100K00.060.S	13677	130x1000 mm	60 mm	1	326.70
2013.100K00.080.S	13678	130x1000 mm	80 mm	1	343.40
2013.100K00.100.S	13679	130x1000 mm	100 mm	1	356.70
2013.100K00.150.S	13680	130x1000 mm	150 mm	1	433.40
2013.100K00.200.S	13681	130x1000 mm	200 mm	1	550.00

ÇİTALİ POLİMER KANAL 130x1000 mm

Ürün Kodu	Kısa Kod	Ölçü	Yükseklik		Fiyat
2013.100K00.060.Ç	13682	130x1000 mm	60 mm	1	366.70
2013.100K00.080.Ç	13684	130x1000 mm	80 mm	1	390.00
2013.100K00.100.Ç	13686	130x1000 mm	100 mm	1	420.00
2013.100K00.150.Ç	13687	130x1000 mm	150 mm	1	466.70

KANAL TAPASI 130 mm

Ürün Kodu	Kısa Kod	Ölçü	Yükseklik		Fiyat
2013.000T00.060.S	13711	130x60 mm	60 mm	1	46.70
2013.000T00.080.S	13713	130x80 mm	80 mm	1	46.70
2013.000T00.100.S	13715	130x100 mm	100 mm	1	46.70
2013.000T00.150.S	13717	130x150 mm	150 mm	1	60.00
2013.000T00.200.S	13718	130x200 mm	200 mm	1	60.00

PASLANMAZ IZGARA 130 mm

Ürün Kodu	Kısa Kod	Ölçü	Kalite	Desen	Fiyat
2113.05020P304.2	13811	130x500 mm	S.S.304	Kare	126.70
2113.05020P304.4	13788	130x500 mm	S.S.304	Standart	113.40
2113.10020P304.2	13833	130x1000 mm	S.S.304	Kare	260.00
2113.10020P304.4	13821	130x1000 mm	S.S.304	Standart	223.40
2113.05020P430.4	13797	130x500 mm	Galvaniz	Standart	63.40
2113.10021P430.4	13825	130x1000 mm	Galvaniz	Standart	113.40

PİK DÖKÜM 130 mm

Ürün Kodu	Kısa Kod	Ölçü	Kalite	Desen	Fiyat
2113.05020D.000.4	18172	130x500 mm	Pik Döküm	Standart	183.40

POLİMER KANAL 200x1000 mm

Ürün Kodu	Kısa Kod	Ölçü	Yükseklik		Fiyat
2020.100K00.060.S	13689	200x1000 mm	60 mm	1	346.70
2020.100K00.080.S	13690	200x1000 mm	80 mm	1	363.40
2020.100K00.120.S	13691	200x1000 mm	120 mm	1	460.00
2020.100K00.150.S	13692	200x1000 mm	150 mm	1	500.00
2020.100K00.200.S	13693	200x1000 mm	200 mm	1	550.00
2020.100K00.250.S	13694	200x1000 mm	250 mm	1	623.40

ÇITALI POLİMER KANAL 200x1000 mm

Ürün Kodu	Kısa Kod	Ölçü	Yükseklik		Fiyat
2020.100K00.060.Ç	13695	200x1000 mm	60 mm	1	380.00
2020.100K00.080.Ç	13696	200x1000 mm	80 mm	1	433.40
2020.100K00.120.Ç	13697	200x1000 mm	120 mm	1	500.00
2020.100K00.150.Ç	13698	200x1000 mm	150 mm	1	526.70
2020.100K00.200.Ç	13699	200x1000 mm	200 mm	1	580.00
2020.100K00.300.Ç	13700	200x1000 mm	300 mm	1	743.40
2020.100K00.400.Ç	13701	200x1000 mm	400 mm	1	933.40

KANAL TAPASI 200 mm

Ürün Kodu	Kısa Kod	Ölçü	Yükseklik		Fiyat
2020.000T00.060.S	13719	200x60 mm	60 mm	1	50.00
2020.000T00.080.S	13720	200x80 mm	80 mm	1	50.00
2020.000T00.120.S	13721	200x120 mm	120 mm	1	66.70
2020.000T00.150.S	13722	200x150 mm	150 mm	1	66.70
2020.000T00.200.S	13723	200x200 mm	200 mm	1	66.70
2020.000T00.300.S	13724	200x300 mm	300 mm	1	86.70
2020.000T00.400.S	27542	200x400 mm	400 mm	1	90.00

PASLANMAZ IZGARA 200 mm

Ürün Kodu	Kısa Kod	Ölçü	Kalite	Desen	Fiyat
2120.05021P304.2	13861	200x500 mm	S.S.304	Kare	253.40
2120.05021P304.3	13851	200x500 mm	S.S.304	Çizgi	253.40
2120.05021P304.4	13840	200x500 mm	S.S.304	Standart	250.00
2120.05021P430.4	13849	200x500 mm	Galvaniz	Standart	190.00

SFERO DÖKÜM 200 mm

Ürün Kodu	Kısa Kod	Ölçü	Kalite	Desen	Fiyat
2120.05020D.000.4	18181	200x500 mm	Pik Döküm	Standart	313.40

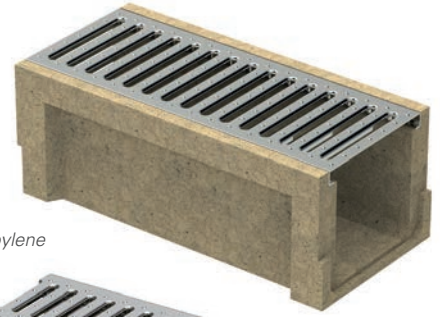

• Polypropylene

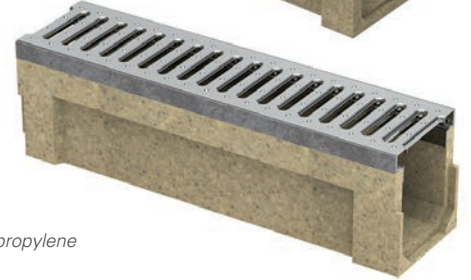

• Polypropylene

* Alt Çıkışlar İsteğe Bağlıdır. Sipariş Esnasında Belirtiniz.
* Görseldeki Izgara birim fiyata dahil değildir.



• Polypropylene



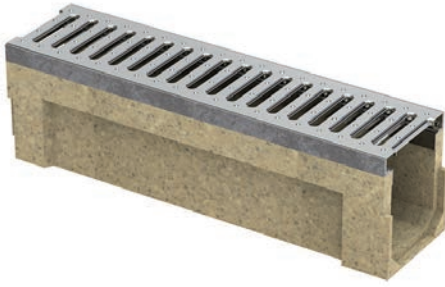

• Polypropylene

* Alt Çıkışlar İsteğe Bağlıdır. Sipariş Esnasında Belirtiniz.
* Görseldeki Izgara birim fiyata dahil değildir.

ÇITALI POLİMER KANAL 300x1000 mm

Ürün Kodu	Kısa Kod	Ölçü	Yükseklik		Fiyat
2030.100K00.080.Ç	13704	300x1000 mm	80 mm	1	533.40
2030.100K00.120.Ç	13705	300x1000 mm	120 mm	1	576.70
2030.100K00.150.Ç	13706	300x1000 mm	150 mm	1	623.40
2030.100K00.200.Ç	13707	300x1000 mm	200 mm	1	700.00
2030.100K00.250.Ç	13708	300x1000 mm	250 mm	1	800.00



• Polypropylene

KANAL TAPASI 300 mm

Ürün Kodu	Kısa Kod	Ölçü	Yükseklik		Fiyat
2030.000T00.080.S	13725	300x80 mm	80 mm	1	63.40
2030.000T00.120.S	13726	300x120 mm	120 mm	1	63.40
2030.000T00.150.S	13727	300x150 mm	150 mm	1	63.40
2030.000T00.200.S	13728	300x200 mm	200 mm	1	83.40
2030.000T00.250.S	13729	300x250 mm	250 mm	1	83.40



PASLANMAZ IZGARA 300 mm

Ürün Kodu	Kısa Kod	Ölçü	Kalite	Desen	Fiyat
2130.05021P304.4	13871	300x500 mm	S.S.304	Kare	350.00



SFERO DÖKÜM 300 mm

Ürün Kodu	Kısa Kod	Ölçü	Kalite	Desen	Fiyat
2130.05020D.000.4	21862	300x500 mm	Pik Döküm	Standart	540.00

OTOPARK SIFONLARI

MAXIFLOW

A.Ç. 15x15

Ürün Kodu	Kısa Kod	Çıkış	Ölçü	Fiyat
2215.15A070.065.P	13737	Ø 70	15x15 cm	425.00

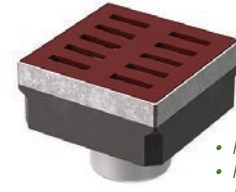

- Pik döküm gövde
- Pik ızgara
- Koku tutucu

A.Ç. 20x20

Ürün Kodu	Kısa Kod	Çıkış	Ölçü	Fiyat
2220.20A100.080.P	13739	Ø 100	20x20 cm	525.90

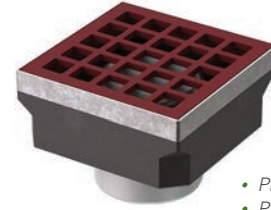

- Pik döküm gövde
- Pik ızgara
- Koku tutucu

A.Ç. 30x30

Ürün Kodu	Kısa Kod	Çıkış	Ölçü	Fiyat
2230.30A100.070.P	13741	Ø 100	20x20 cm	980.00

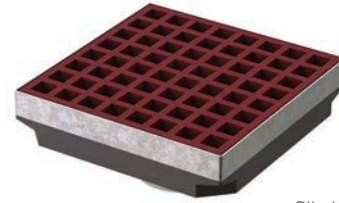

- Pik döküm gövde
- Pik ızgara
- Koku tutucu

A.Ç. 200x500

Ürün Kodu	Kısa Kod	Çıkış	Ölçü	Fiyat
2230.50A070.100.P	13742	Ø 100	200x500 cm	816.70



- Pik döküm gövde
- Paslanmaz ızgara
- Koku tutucu

A.Ç. 200x500

Ürün Kodu	Kısa Kod	Çıkış	Ölçü	Fiyat
2230.50A070.100.D	13744	Ø 100	200x500 cm	866.70



- Pik döküm gövde
- Pik döküm ızgara
- Koku tutucu

20x20



- Ø 70 yan - alt çıkış
- Plastik gövde
- Plastik ızgara



- Ø 100 yan - alt çıkış
- Plastik gövde
- Plastik ızgara

Ürün Kodu	Kısa Kod	Çıkış	Ölçü	İkili	Fiyat
-----------	----------	-------	------	-------	-------



1101.2020Y0.070.0	13748	Ø 70	20x20	30	43.40
-------------------	-------	------	-------	----	-------



1101.2020A0.070.0	13750	Ø 70	20x20	30	42.00
-------------------	-------	------	-------	----	-------

25x25

Ürün Kodu	Kısa Kod	Çıkış	Ölçü	İkili	Fiyat
-----------	----------	-------	------	-------	-------



1101.2525Y0.100.0	13755	Ø 100	25x25	20	66.40
-------------------	-------	-------	-------	----	-------



1101.2525A0.100.0	13756	Ø 100	25x25	20	62.70
-------------------	-------	-------	-------	----	-------

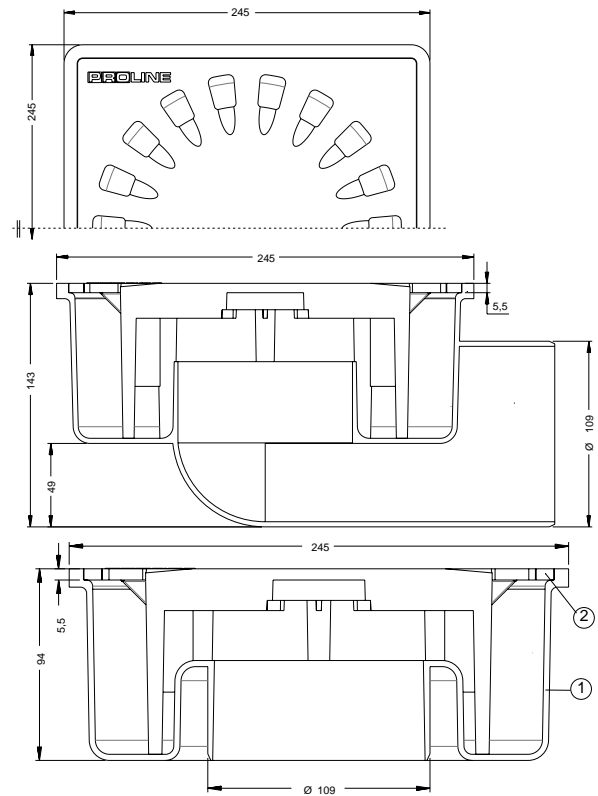
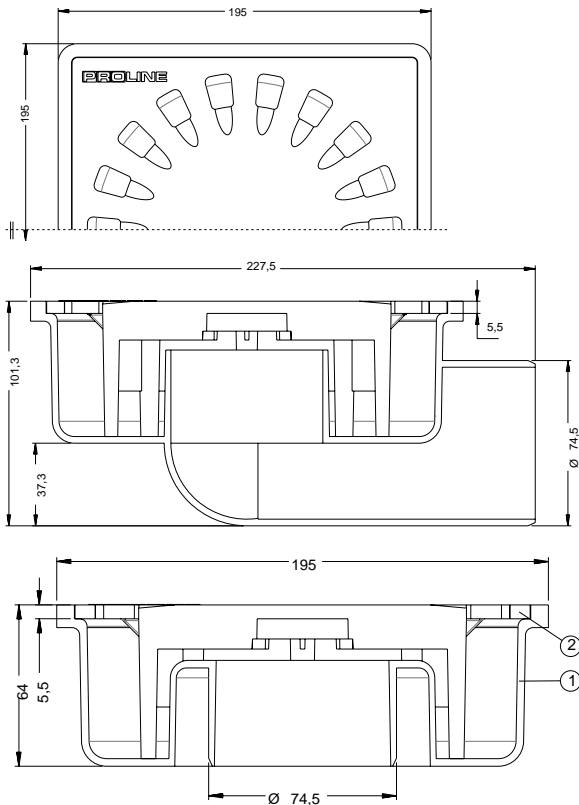



AKSESUARLAR

VOGUE MAT GOLD SERİSİ



ETAJER

Ürün Kodu	Kısa Kod		Fiyat
AK.200.3801.G	28850	10	541.00



DİŞ FIRÇALIK

Ürün Kodu	Kısa Kod		Fiyat
AK.202.3904.G	28852	12	299.00



UZUN HAVLULUK

Ürün Kodu	Kısa Kod		Fiyat
AK.204.3814.G	28853	15	684.00



WC KAĞITLIK

Ürün Kodu	Kısa Kod		Fiyat
AK.206.3807.G	28856	20	392.30



MAXIFLOW



SABUNLUK

Ürün Kodu	Kısa Kod		Fiyat
AK.201.3803.G	28851	12	299.00



BORNOZ ASKILIĞI

Ürün Kodu	Kısa Kod		Fiyat
AK.205.3827.G	28857	20	271.00



YUVARLAK HAVLULUK

Ürün Kodu	Kısa Kod		Fiyat
AK.203.3817.G	28854	10	462.30



WC KAPAKLI KAĞITLIK

Ürün Kodu	Kısa Kod		Fiyat
AK.207.3808.G	28855	20	476.00

FASHION GOLD SERİSİ

YENİ!



ETAJER

Ürün Kodu	Kısa Kod		Fiyat
AK.173.3801.G	28834	10	296.40



DİŞ FIRÇALIK

Ürün Kodu	Kısa Kod		Fiyat
AK.175.3804.G	28836	12	175.00



UZUN HAVLULUK

Ürün Kodu	Kısa Kod		Fiyat
AK.177.3814.G	28837	15	354.00

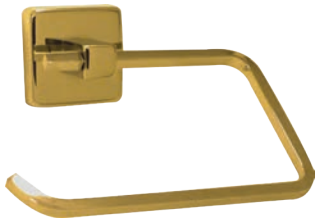

WC KAĞITLIK

Ürün Kodu	Kısa Kod		Fiyat
AK.179.3807.G	28840	20	210.70

MAXIFLOW



SABUNLUK

Ürün Kodu	Kısa Kod		Fiyat
AK.174.3803.G	28835	12	175.00



BORNOZ ASKILIĞI

Ürün Kodu	Kısa Kod		Fiyat
AK.178.3827.G	28841	20	154.70

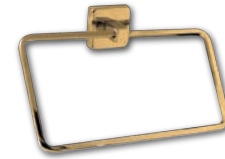

YUVARLAK HAVLULUK

Ürün Kodu	Kısa Kod		Fiyat
AK.176.3817.G	28838	10	270.00



WC KAPAKLI KAĞITLIK

Ürün Kodu	Kısa Kod		Fiyat
AK.180.3808.G	28839	20	266.70

YENİ!



ETAJER

Ürün Kodu	Kısa Kod		Fiyat
AK.185.3801.B	28842	5	299.70



DİŞ FIRÇALIK

Ürün Kodu	Kısa Kod		Fiyat
AK.187.3804.B	28844	14	190.00



UZUN HAVLULUK

Ürün Kodu	Kısa Kod		Fiyat
AK.189.3814.B	28845	10	353.00



WC KAĞITLIK

Ürün Kodu	Kısa Kod		Fiyat
AK.191.3807.B	28848	24	210.70



SABUNLUK

Ürün Kodu	Kısa Kod		Fiyat
AK.186.3803.B	28843	16	175.00



BORNOZ ASKILIĞI

Ürün Kodu	Kısa Kod		Fiyat
AK.190.3827.B	28849	20	154.70



YUVARLAK HAVLULUK

Ürün Kodu	Kısa Kod		Fiyat
AK.188.3817.B	28846	8	270.00



WC KAPAKLI KAĞITLIK

Ürün Kodu	Kısa Kod		Fiyat
AK.192.3808.B	28847	8	266.70



ETAJER

Ürün Kodu	Kısa Kod		Fiyat
AK.01.3901.P	13437	12	200.00



DİŞ FIRÇALIK

Ürün Kodu	Kısa Kod		Fiyat
AK.01.3904.P	13439	10	146.70



UZUN HAVLULUK

Ürün Kodu	Kısa Kod		Fiyat
AK.06.3914.P	13442	15	213.30



WC KAĞITLIK

Ürün Kodu	Kısa Kod		Fiyat
AK.04.3907.P	13444	36	145.70



SABUNLUK

Ürün Kodu	Kısa Kod		Fiyat
AK.01.3903.P	13438	27	146.70



BORNOZ ASKILIĞI

Ürün Kodu	Kısa Kod		Fiyat
AK.08.3927.P	13443	20	94.00



YUVARLAK HAVLULUK

Ürün Kodu	Kısa Kod		Fiyat
AK.01.3917.P	13440	15	159.40



WC KAPAKLI KAĞITLIK

Ürün Kodu	Kısa Kod		Fiyat
AK.05.3908.P	13445	27	177.70

- Krom kaplama
- Zamak gövde

- SS 304 kalite paslanmaz kapak ve boru
- Kutu ambalaj

JÜPİTER SERİSİ



ETAJER

Ürün Kodu	Kısa Kod		Fiyat
AK.20.3401.P	13454	9	198.00



DİŞ FIRÇALIK

Ürün Kodu	Kısa Kod		Fiyat
AK.22.3404.P	13456	25	141.00



UZUN HAVLULUK

Ürün Kodu	Kısa Kod		Fiyat
AK.26.3414.P	13458	15	184.40



WC KAĞITLIK

Ürün Kodu	Kısa Kod		Fiyat
AK.23.3407.P	13460	36	96.70



WC KAPAKLI KAĞITLIK

Ürün Kodu	Kısa Kod		Fiyat
AK.35.3408.G	13471	23	185.00

- Krom kaplama
- Prinç gövde

MAXIFLOW



SABUNLUK

Ürün Kodu	Kısa Kod		Fiyat
AK.21.3403.P	13455	30	140.70



BORNOZ ASKILIĞI

Ürün Kodu	Kısa Kod		Fiyat
AK.29.3427.P	13459	20	136.00



YUVARLAK HAVLULUK

Ürün Kodu	Kısa Kod		Fiyat
AK.27.3417.P	13457	16	144.40



WC KAPAKLI KAĞITLIK

Ürün Kodu	Kısa Kod		Fiyat
AK.24.3408.P	13461	23	124.70



KAPAKLI KAĞIT HAVLULUK

Ürün Kodu	Kısa Kod		Fiyat
AK.25.3413.P	13463	15	138.40

- SS 304 kalite paslanmaz kapak , Rozet ve çubuk
- Kutu ambalaj



ETAJER

Ürün Kodu	Kısa Kod		Fiyat
AK.88.3301.P	26145	5	248.00



DİŞ FIRÇALIK

Ürün Kodu	Kısa Kod		Fiyat
AK.90.3304.P	26147	14	192.40



UZUN HAVLULUK

Ürün Kodu	Kısa Kod		Fiyat
AK.93.3314.P	26150	10	299.70



BORNOZ ASKILIĞI

Ürün Kodu	Kısa Kod		Fiyat
AK.94.3327.P	26151	50	126.00



SABUNLUK

Ürün Kodu	Kısa Kod		Fiyat
AK.89.3303.P	26146	16	191.70



WC KAĞITLIK

Ürün Kodu	Kısa Kod		Fiyat
AK.91.3307.P	26148	16	187.00



AÇIK HAVLULUK

Ürün Kodu	Kısa Kod		Fiyat
AK.92.3317.P	26149	8	231.40



TEKLİ BORNOZ ASKILIĞI

Ürün Kodu	Kısa Kod		Fiyat
AK.96.3326.P	26153	50	109.00

- Krom kaplama
- Prinç gövde

- SS 304 kalite paslanmaz kapak , Rozet ve çubuk
- Kutu ambalaj



ETAJER

Ürün Kodu	Kısa Kod		Fiyat
AK.100.3301.G	26154	5	222.40



SABUNLUK

Ürün Kodu	Kısa Kod		Fiyat
AK.101.3303.G	26155	16	222.70



DİŞ FIRÇALIK

Ürün Kodu	Kısa Kod		Fiyat
AK.102.3304.G	26156	14	222.70



WC KAĞITLIK

Ürün Kodu	Kısa Kod		Fiyat
AK.103.3307.G	26157	16	217.70



UZUN HAVLULUK

Ürün Kodu	Kısa Kod		Fiyat
AK.105.3314.G	26159	10	360.80



AÇIK HAVLULUK

Ürün Kodu	Kısa Kod		Fiyat
AK.104.3317.G	26158	8	262.00



BORNOZ ASKILIĞI

Ürün Kodu	Kısa Kod		Fiyat
AK.106.3327.G	26160	50	156.70



TEKLİ BORNOZ ASKILIĞI

Ürün Kodu	Kısa Kod		Fiyat
AK.108.3326.G	26162	50	139.40

- Krom kaplama
- Prinç gövde

- SS 304 kalite paslanmaz kapak , Rozet ve çubuk
- Kutu ambalaj



ETAJER

Ürün Kodu	Kısa Kod		Fiyat
AK.74.3801.P	26134	5	256.40



DİŞ FIRÇALIK

Ürün Kodu	Kısa Kod		Fiyat
AK.76.3804.P	26136	14	154.30



UZUN HAVLULUK

Ürün Kodu	Kısa Kod		Fiyat
AK.80.3814.P	26140	10	290.70



WC KAĞITLIK

Ürün Kodu	Kısa Kod		Fiyat
AK.77.3807.P	26137	24	171.00



SABUNLUK

Ürün Kodu	Kısa Kod		Fiyat
AK.75.3803.P	26135	16	153.70



BORNOZ ASKILIĞI

Ürün Kodu	Kısa Kod		Fiyat
AK.81.3827.P	26141	İKİLİ V 20	108.00
AK.84.3826.P	26144	TEKLI 20	97.40
AK.95.3827.P	28971	İKİLİ U 20	123.00



YUVARLAK HAVLULUK

Ürün Kodu	Kısa Kod		Fiyat
AK.79.3817.P	26139	8	226.40



WC KAPAKLI KAĞITLIK

Ürün Kodu	Kısa Kod		Fiyat
AK.78.3808.P	26138	8	188.00

- Krom kaplama
- Prinç gövde

- SS 304 kalite paslanmaz kapak , Rozet ve çubuk
- Kutu ambalaj



ETAJER

Ürün Kodu	Kısa Kod		Fiyat
AK.31.3601.P	13474	20	89.00



DİŞ FIRÇALIK

Ürün Kodu	Kısa Kod		Fiyat
AK.33.3604.P	13479	20	64.00



UZUN HAVLULUK

Ürün Kodu	Kısa Kod	Uzunluk		Fiyat
AK.40.3614.P	13475	40 cm	20	89.00



WC KAĞITLIK

Ürün Kodu	Kısa Kod		Fiyat
AK.34.3607.P	13480	20	68.40



SABUNLUK

Ürün Kodu	Kısa Kod		Fiyat
AK.32.3603.P	13477	20	64.00



BORNOZ ASKILIĞI ÇİFTLİ

Ürün Kodu	Kısa Kod		Fiyat
AK.44.3621.P	13486	20	47.40



YUVARLAK HAVLULUK

Ürün Kodu	Kısa Kod		Fiyat
AK.42.3617.P	13481	20	68.40



WC KAPAKLI KAĞITLIK

Ürün Kodu	Kısa Kod		Fiyat
AK.35.3608.P	13482	20	80.70

- Krom kaplama
- Prinç gövde

- SS 304 kalite paslanmaz kapak , Rozet ve çubuk
- Vakumlu



KAĞIT HAVLULUK

Ürün Kodu

Kısa Kod



Fiyat

AK.38.3612.P

13483

20

68.00



KAPAKLI KAĞIT HAVLULUK

Ürün Kodu

Kısa Kod



Fiyat

AK.39.3613.P

13485

15

80.70

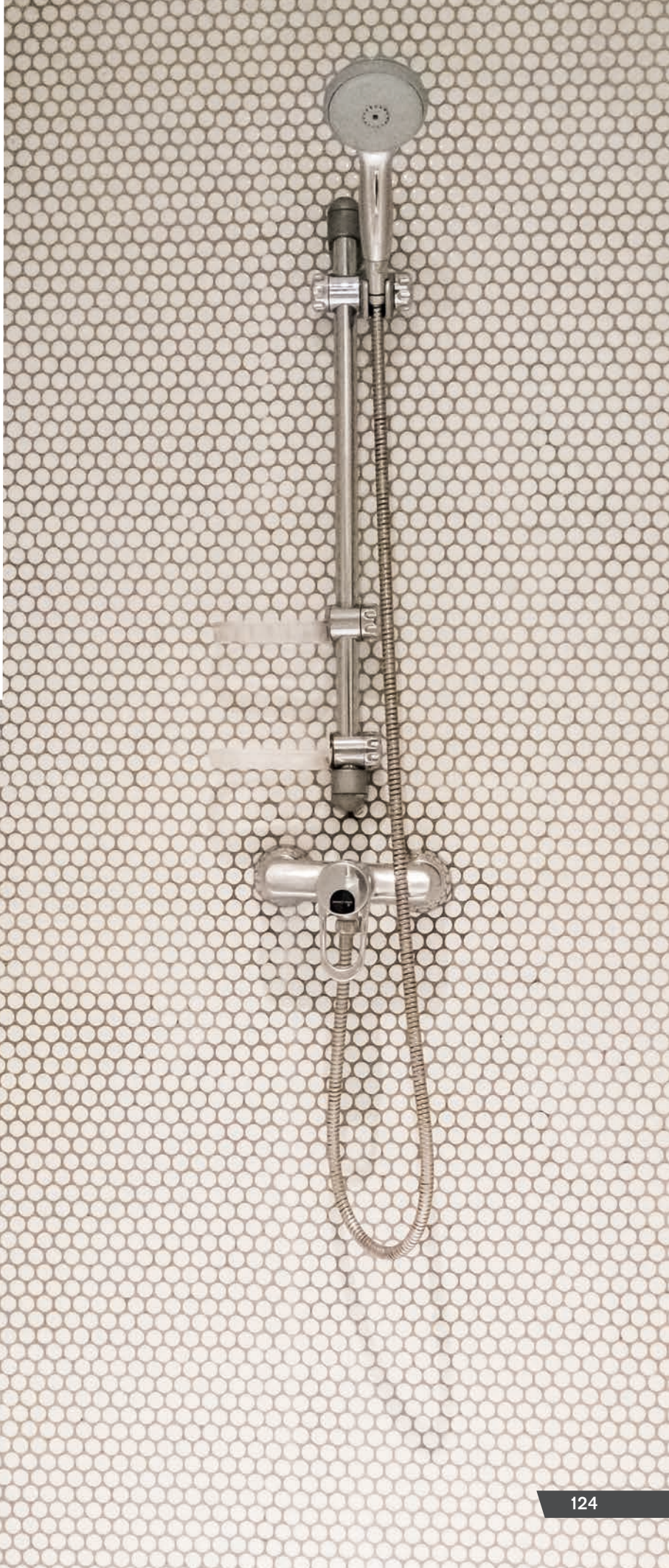



ETAJER

Ürün Kodu	Kısa Kod		Fiyat
AK.181.4501.P	28972	24	79.70



SABUNLUK

Ürün Kodu	Kısa Kod		Fiyat
AK.171.4503.P	28868	24	31.70



DİŞ FIRÇALIK

Ürün Kodu	Kısa Kod		Fiyat
AK.172.4504.P	28869	24	31.70



BORNOZ ASKILIĞI ÇİFTLİ

Ürün Kodu	Kısa Kod		Fiyat
AK.155.4527.P	28874	24	37.70



UZUN HAVLULUK

Ürün Kodu	Kısa Kod	Uzunluk		Fiyat
AK.167.4514.P	28862	40 cm	24	56.50



YUVARLAK HAVLULUK

Ürün Kodu	Kısa Kod		Fiyat
AK.168.4518.P	28863	24	36.90



WC KAĞITLIK

Ürün Kodu	Kısa Kod		Fiyat
AK.163.4507.P	28858	24	31.40

WC KAPAKLI KAĞITLIK

Ürün Kodu	Kısa Kod		Fiyat
AK.164.4508.P	28859	24	41.70



ETAJER

Ürün Kodu	Kısa Kod		Fiyat
AK.157.4501.B	28884	24	79.70



SABUNLUK

Ürün Kodu	Kısa Kod		Fiyat
AK.156.4503.B	28885	24	67.80



DİŞ FIRÇALIK

Ürün Kodu	Kısa Kod		Fiyat
AK.158.4504.B	28886	24	67.80



BORNOZ ASKILIĞI ÇİFTLİ

Ürün Kodu	Kısa Kod		Fiyat
AK.170.4527.B	28883	24	47.20



UZUN HAVLULUK

Ürün Kodu	Kısa Kod	Uzunluk		Fiyat
AK.153.4514.B	28880	40 cm	24	85.30



YUVARLAK HAVLULUK

Ürün Kodu	Kısa Kod		Fiyat
AK.154.4517.B	28881	24	49.30



WC KAĞITLIK

Ürün Kodu	Kısa Kod		Fiyat
AK.151.4507.B	28876	24	42.70



WC KAPAKLI KAĞITLIK

Ürün Kodu	Kısa Kod		Fiyat
AK.152.4508.B	28877	24	56.50



ETAJER

Ürün Kodu	Kısa Kod		Fiyat
AK.61.3501.P	26124	12	67.40



DİŞ FIRÇALIK

Ürün Kodu	Kısa Kod		Fiyat
AK.62.3504.P	26125	20	41.00



UZUN HAVLULUK

Ürün Kodu	Kısa Kod		Fiyat
AK.65.3514.P	26128	15	70.70



WC KAĞITLIK

Ürün Kodu	Kısa Kod		Fiyat
AK.67.3507.P	26130	20	41.00



SABUNLUK

Ürün Kodu	Kısa Kod		Fiyat
AK.63.3503.P	26126	16	42.40



BORNOZ ASKILIĞI

Ürün Kodu	Kısa Kod		Fiyat
AK.66.3527.P	26129	24	33.40



YUVARLAK HAVLULUK

Ürün Kodu	Kısa Kod		Fiyat
AK.64.3517.P	26127	15	50.00



WC KAPAKLI KAĞITLIK

Ürün Kodu	Kısa Kod		Fiyat
AK.68.3508.P	26131	20	48.70

- Krom kaplama
- Alüminyum gövde

- SS 430 kalite paslanmaz Rozet ve kapak
- Demir çubuk
- Blister Ambalaj



OVAL AYNA

Ürün Kodu	Kısa Kod	Ölçü		Fiyat
AK.94.4002.A	13499	54x74 cm	5	265.00



LAVİ AYNA

Ürün Kodu	Kısa Kod	Ölçü		Fiyat
AK.90.4202.A	13501	40x50 cm	5	141.70



MAKYAJ AYNASI

Ürün Kodu	Kısa Kod		Fiyat
AK.96.3001.A	13505	20	500.00
LEDLİ			
AK.97.3002.A	13506	20	866.70



DİKDÖRTGEN AYNA

Ürün Kodu	Kısa Kod	Ölçü		Fiyat
AK.95.4102.A	13500	55x75 cm	5	261.70



MİRA AYNA

Ürün Kodu	Kısa Kod	Ölçü		Fiyat
AK.91.4301.A	13502	40x50 cm	5	130.00
AK.92.4302.A	13503	40x60 cm	5	148.40
AK.93.4303.A	13504	50x70 cm	5	208.40





A TİPİ SET ASKILIK

Ürün Kodu	Kısa Kod	Ölçü	İkisi	Fiyat
AK.280.8002.A	13518	2'li Set Askılık	24	76.00
AK.281.8003.A	13519	3'lü Set Askılık	24	93.40
AK.281.8004.A	13520	4'lü Set Askılık	24	118.70
AK.282.8005.A	13521	5'li Set Askılık	24	141.70



B TİPİ SET ASKILIK

Ürün Kodu	Kısa Kod	Ölçü	İkisi	Fiyat
AK.285.8002.B	13522	2'li Set Askılık	24	68.40
AK.286.8003.B	13523	3'lü Set Askılık	24	88.40
AK.286.8004.B	13524	4'lü Set Askılık	24	113.40
AK.287.8005.B	13525	5'li Set Askılık	24	135.00



ASKILIK 2'Lİ 3'LÜ

Ürün Kodu	Kısa Kod	Ölçü	İkisi	Fiyat
AK.70.4521.P	28866	2'li	24	36.40
AK.71.4529.P	28867	3'lü	24	40.70



ROZETLİ ASKILIK

Ürün Kodu	Kısa Kod	Ölçü	İkisi	Fiyat
AK.47.4529.P	28870	3'lü	24	68.50
AK.57.4529.P	28871	4'lü	24	75.30
AK.58.4529.P	28872	5'li	24	82.80



3'LÜ AKSESUAR SET

Ürün Kodu	Kısa Kod	Ölçü	Fiyat
AK.330.4500.P	28873	18	108.50



3'LÜ BLACK SET

Ürün Kodu	Kısa Kod	Ölçü	Fiyat
AK.440.4500.B	28875	18	139.00



TEKLİ KÖŞE SÜNGERLİK

Ürün Kodu	Kısa Kod	Ölçü	İkili	Fiyat
AK.61.6018.K	13509	18x18 cm	10	169.40



İKİLİ KÖŞE SÜNGERLİK

Ürün Kodu	Kısa Kod	Ölçü	İkili	Fiyat
AK.61.6118.K	13512	18x18 cm	10	353.40



ÜÇLÜ KÖŞE SÜNGERLİK

Ürün Kodu	Kısa Kod	Ölçü	İkili	Fiyat
AK.73.6218.K	13516	18x18 cm	12	493.40

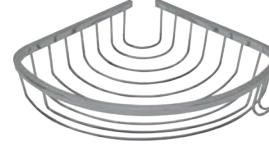

TEKLİ OVAL SÜNGERLİK

Ürün Kodu	Kısa Kod	Ölçü	İkili	Fiyat
AK.62.6519.K	13510	19x19 cm	10	200.00
GOLD				
AK.210.6318.G	28890	19x19 cm	10	300.00

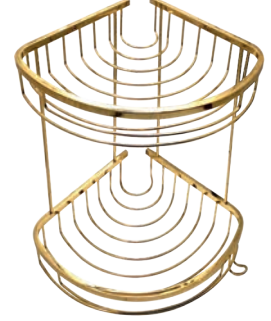

İKİLİ OVAL SÜNGERLİK

Ürün Kodu	Kısa Kod	Ölçü	İkili	Fiyat
AK.69.6619.K	13513	19x19 cm	10	416.70
GOLD				
AK.211.6418.G	28891	19x19 cm	8	620.00

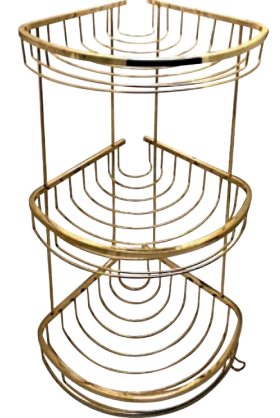

ÜÇLÜ OVAL SÜNGERLİK

Ürün Kodu	Kısa Kod	Ölçü	İkili	Fiyat
AK.254.6719.K	13515	19x19 cm	12	590.00
GOLD				
AK.212.6518.G	28892	19x19 cm	4	883.40



LAMALI RAF HAVLULUK

Ürün Kodu	Kısa Kod	Çap	Ölçü	Kalite	Fiyat
4949.3051S.304.00	13526	Ø 19	50x29x12,5 cm	S.S. 304	12 263.40



RAF HAVLULUK

Ürün Kodu	Kısa Kod	Çap	Ölçü	Kalite	Fiyat
4949.3162S.304.00	13527	Ø 19	50x20x13 cm	S.S. 304	25 235.00

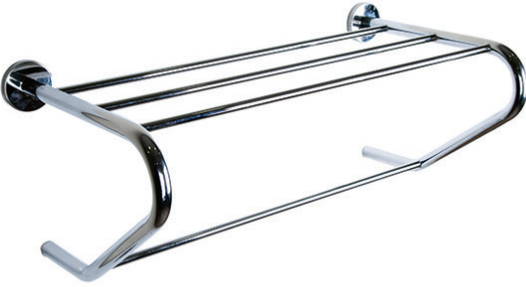

AÇILI DESTEKLİ RAF HAVLULUK

Ürün Kodu	Kısa Kod	Çap	Ölçü	Kalite	Fiyat
4950.5019S.304.00	13528	Ø 19	50x28x19 cm	S.S. 304	12 256.70



DESTEKLİ RAF HAVLULUK

Ürün Kodu	Kısa Kod	Çap	Ölçü	Kalite	Fiyat
4950.3162S.304.00	13529	Ø 19	50x29x12 cm	S.S. 304	12 250.00



ÇİFT KAT RAF HAVLULUK

Ürün Kodu	Kısa Kod	Ölçü	Kalite	Fiyat
4947.3051S.304.00	28893	50x27x13 cm	S.S. 304	1 331.00



PASLANMAZ ETAJER

Ürün Kodu	Kısa Kod	Ölçü	Kalite	Fiyat
AK.161.4709.P	27288	47x9x4 cm	S.S. 304	1 103.40
AK.162.4710.P	27289	47x9x4 cm	S.S. 304	1 153.40



Parlak

DİŞ FIRÇALIK

Ürün Kodu	Kısa Kod	Ölçü	Kalite	İkili	Fiyat
4711.22.711.0	13530	Ø 7x11 cm	S.S. 304	20	53.40



SET ÜSTÜ / ASKILIKLI

Ürün Kodu	Kısa Kod	Ölçü	Kalite	İkili	Fiyat
4711.17.718.0	13413	Ø 7x17 cm	S.S. 304	20	70.00
4711.16.717.0	13414	Askılı Ø 7x17 cm	S.S. 304	20	80.00



ANKASTRE

Ürün Kodu	Kısa Kod	Çap	Ölçü	Kalite	İkili	Fiyat
4716.0921S.304.00	13426	Ø 9	21 cm	S.S. 304	20	108.40
4716.0921S.304.01	13427	Ø 9	21 cm	S.S. 304	20	330.00

KÖPÜKLÜ



Duvara Montaj

Plastik Pompa

Mat

Parlak

KÖPÜKLÜ

Ürün Kodu	Kısa Kod	Kapasite	Ölçü	Kalite	İkili	Fiyat
4711.09.100.M	13411	1000 ml	22x6x13 cm	S.S. 304	20	196.70
4711.09.100.P	13412	1000 ml	22x6x13 cm	S.S. 304	20	203.40



KÜRE SET ÜSTÜ

Ürün Kodu	Kısa Kod	Ölçü	Kalite	İkili	Fiyat
4711.19.916.0	13416	Ø 9x14.5 cm	S.S. 304	20	75.00



DEZENFEKTAN APARATI

Ürün Kodu	Kısa Kod	Ölçü	Kalite	İkili	Fiyat
HD.99.0000.PL	28894	21 cm	ABS	40	33.40
HD.99.0304.KR	13427	21 cm	S.S. 304	20	170.00



Duvara
Montaj

Plastik
Pompa

Parlak

SABUNLUK

Ürün Kodu	Kısa Kod	Kapasite	Ölçü	Kalite	İkili	Fiyat
4711.02.050.P	13417	500 ml	16x6x10 cm	S.S. 304	20	143.40
4711.06.100.P	13419	1000 ml	22x6x13 cm	S.S. 304	20	173.40



Duvara
Montaj

Plastik
Pompa

Mat

SABUNLUK

Ürün Kodu	Kısa Kod	Kapasite	Ölçü	Kalite	İkili	Fiyat
4711.01.050.M	13420	500 ml	16x6x10 cm	S.S. 304	20	140.00
4711.05.100.M	13421	1000 ml	22x6x13 cm	S.S. 304	20	170.00



Duvara
Montaj

Pirinç
Pompa

Parlak

SABUNLUK

Ürün Kodu	Kısa Kod	Kapasite	Ölçü	Kalite	İkili	Fiyat
4711.04.050.P	13422	500 ml	16x6x10 cm	S.S. 304	20	150.00
4711.08.100.P	13423	1000 ml	22x6x13 cm	S.S. 304	20	180.00



Duvara
Montaj

Pirinç
Pompa

Mat

SABUNLUK

Ürün Kodu	Kısa Kod	Kapasite	Ölçü	Kalite	İkili	Fiyat
4711.03.050.M	13424	500 ml	16x6x10 cm	S.S. 304	20	146.70
4711.07.100.M	13425	1000 ml	22x6x13 cm	S.S. 304	20	176.70

KAĞITLIKLAR

ÇÖP KOVALI KAĞITLIK 400'LÜK

Ürün Kodu Kısa Kod Ölçü Kalite Fiyat

OVAL S.S. 430

4546.2610S.430.00	13352	105x26x12 cm	S.S. 430	1	616.70
-------------------	-------	--------------	----------	---	--------

OVAL S.S. 304

4546.2610S.304.00	13351	105x26x12 cm	S.S. 304	1	700.00
-------------------	-------	--------------	----------	---	--------

DÜZ S.S. 430

4549.2610S.430.00	13354	105x26x12 cm	S.S. 430	1	616.70
-------------------	-------	--------------	----------	---	--------

DÜZ S.S. 304

4549.2610S.304.00	13353	105x26x12 cm	S.S. 304	1	700.00
-------------------	-------	--------------	----------	---	--------



Z KATLAMA KAĞIT HAVLULUK

Ürün Kodu Kısa Kod Ölçü Kalite Fiyat

S.S. 430

4922.2026P.430.00	13365	200'lük	20.5x27x10 cm	S.S. 430	20	136.70
-------------------	-------	---------	---------------	----------	----	--------

4922.3226P.430.00	13367	400'lük	27x35x10 cm	S.S. 430	20	175.40
-------------------	-------	---------	-------------	----------	----	--------

S.S. 304

4922.2026P.304.00	13364	200'lük	20.5x27x10 cm	S.S. 304	20	170.00
-------------------	-------	---------	---------------	----------	----	--------

4922.3226P.304.00	13366	400'lük	27x35x10 cm	S.S. 304	20	223.40
-------------------	-------	---------	-------------	----------	----	--------

RENKLİ BEYAZ

4922.2026B.101.00	28895	200'lük	20.5x27x10 cm		20	166.70
-------------------	-------	---------	---------------	--	----	--------

4922.3226B.101.00	28897	400'lük	27x35x10 cm		20	216.70
-------------------	-------	---------	-------------	--	----	--------

RENKLİ SİYAH

4922.2026S.102.00	28896	200'lük	20.5x27x10 cm		20	166.70
-------------------	-------	---------	---------------	--	----	--------

4922.3226S.102.00	28898	400'lük	27x35x10 cm		20	216.70
-------------------	-------	---------	-------------	--	----	--------



JUMBO WC KAĞIT VERİCİ

Ürün Kodu	Kısa Kod	Çap	Ölçü	Kalite	Fiyat
-----------	----------	-----	------	--------	-------

S.S. 430

4923.2212S.430.00	13370	Ø 22	12 cm	S.S. 430	20	143.40
4923.2712S.430.00	13372	Ø 27	12 cm	S.S. 430	20	166.70

S.S. 304

4923.2212S.304.00	13369	Ø 22	12 cm	S.S. 304	20	163.40
4923.2712S.304.00	13371	Ø 27	12 cm	S.S. 304	20	176.70

RENKLİ BEYAZ

4923.2212B.101.00	28899	Ø 22	12 cm		20	185.40
4923.2712B.101.00	28901	Ø 27	12 cm		20	203.40

RENKLİ SİYAH

4923.2212S.102.00	28900	Ø 22	12 cm		20	185.40
4923.2712S.102.00	28902	Ø 27	12 cm		20	203.40



GÜLEN AĞIZ KAĞIT VERİCİ

Ürün Kodu	Kısa Kod	Ölçü	Kalite	Fiyat
-----------	----------	------	--------	-------

S.S. 430

4923.2739S.430.00	13374	28x5.5x39 cm	S.S. 430	20	110.00
-------------------	-------	--------------	----------	----	--------

S.S. 304

4923.2739S.304.00	13373	28x5.5x39 cm	S.S. 304	20	133.40
-------------------	-------	--------------	----------	----	--------

RENKLİ BEYAZ

4923.2739B.101.00	28905	28x5.5x39 cm		20	140.00
-------------------	-------	--------------	--	----	--------

RENKLİ SİYAH

4923.2739S.102.00	28906	28x5.5x39 cm		20	140.00
-------------------	-------	--------------	--	----	--------

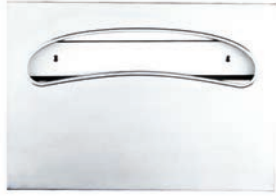

CİMRİ KAĞIT VERİCİ

Ürün Kodu	Kısa Kod	Ölçü	Kalite	Fiyat
-----------	----------	------	--------	-------

S.S. 304

4923.2013S.304.00	13368	Ø 21x13.5 cm	S.S. 304	12	263.40
-------------------	-------	--------------	----------	----	--------

RENKLİ BEYAZ

4923.2013B.101.00	28903	Ø 21x13.5 cm		12	288.70
-------------------	-------	--------------	--	----	--------

RENKLİ SİYAH

4923.2013S.102.00	28904	Ø 21x13.5 cm		12	288.70
-------------------	-------	--------------	--	----	--------



KAĞITLIKLAR

OTOMATİK PLASTİK

Ürün Kodu Kısa Kod Ölçü Fiyat

HD.01.4923.SM 13376 27x22x36 cm 4 1100.00



- ABS gövde
- ABS şeffaf ön kapak

OTOMATİK PLASTİK BEYAZ

Ürün Kodu Kısa Kod Ölçü Fiyat

HD.01.4923.SB 26359 27x22x36 cm 4 1456.70



- ABS gövde
- ABS şeffaf ön pencere

OTOMATİK PLASTİK KROM

Ürün Kodu Kısa Kod Ölçü Fiyat

HD.01.4923.SK 13375 57x33x50 cm 4 1799.40



Z KATLI DİSPANSER

Ürün Kodu Kısa Kod Ölçü Kapasite Fiyat

HD.10.4923.SM 13378 20x22x11 cm 200 12 113.40



- Şeffaf manuel

PLASTİK CİMRİ MİNİ KAĞITLIK

Ürün Kodu Kısa Kod Ölçü Yüze Fiyat

HD.22.4923.SM 13380 Ø20x14 cm Şeffaf 12 143.40



- Şeffaf manuel

KÖPÜK VERİCİ

Ürün Kodu	Kısa Kod	Yüzey	Kapasite	Fiyat
-----------	----------	-------	----------	-------

BEYAZ

HD.40.4720.BY	13428	Beyaz	700 ml.	24	152.00
---------------	-------	-------	---------	----	--------

KROM

HD.41.4720.KR	13429	Krom	700 ml.	24	201.70
---------------	-------	------	---------	----	--------

KÖPÜK VERİCİ

Ürün Kodu	Kısa Kod	Yüzey	Kapasite	Fiyat
-----------	----------	-------	----------	-------

BEYAZ

HD.42.4718.BY	13430	Beyaz	500 ml.	24	155.00
---------------	-------	-------	---------	----	--------

KROM

HD.43.4718.KR	13431	Krom	500 ml.	24	210.00
---------------	-------	------	---------	----	--------

KÖPÜK VERİCİ

Ürün Kodu	Kısa Kod	Yüzey	Kapasite	Fiyat
-----------	----------	-------	----------	-------

ŞEFFAF

HD.38.4717.SM	13432	Şeffaf	350 ml.	24	100.70
HD.39.4717.SM	13433	Şeffaf	650 ml.	24	113.40

İKİZ SIVI SABUNLUK

Ürün Kodu	Kısa Kod	Kapasite	Fiyat
-----------	----------	----------	-------

HD.36.4719.SM	13436	350 ml + 350 ml	12	152.40
---------------	-------	-----------------	----	--------

SIVI SABUNLUK

Ürün Kodu	Kısa Kod	Yüzey	Kapasite	Fiyat
-----------	----------	-------	----------	-------

ŞEFFAF

HD.35.4716.SM	13434	Şeffaf	500 ml.	24	46.70
HD.37.4716.SM	13435	Şeffaf	1000 ml.	24	82.70



• Beyaz



• Krom



• Beyaz



• Krom



BORU KAPAMA ROZETİ TEKLI

Ürün Kodu	Kısa Kod	Ölçü	Yüzey	Yük	Fiyat
-----------	----------	------	-------	-----	-------

BEYAZ

2768.016.00.B	13536	Ø 16 - Ø 17	16 cm	Beyaz	400	10.00
---------------	-------	-------------	-------	-------	-----	-------

KROM

2768.016.00.K	13537	Ø 16 - Ø 17	16 cm	Krom	400	17.70
---------------	-------	-------------	-------	------	-----	-------



• Beyaz



• Krom

BORU KAPAMA ROZETİ ÇİFTLİ

Ürün Kodu	Kısa Kod	Ölçü	Yüzey	Yük	Fiyat
-----------	----------	------	-------	-----	-------

BEYAZ

2768.017.00.B	13538	Ø 16 - Ø 17	16 cm	Beyaz	300	23.40
---------------	-------	-------------	-------	-------	-----	-------

KROM

2768.017.00.K	13539	Ø 16 - Ø 17	16 cm	Krom	300	33.40
---------------	-------	-------------	-------	------	-----	-------



• Beyaz



• Krom

HAVLUPAN ROZETİ

Ürün Kodu	Kısa Kod	Ölçü	Yüzey	Yük	Fiyat
-----------	----------	------	-------	-----	-------

BEYAZ

2768.018.00.B	13540	Ø 16 - Ø 17	5 cm	Beyaz	300	7.70
---------------	-------	-------------	------	-------	-----	------

KROM

2768.018.00.K	13541	Ø 16 - Ø 17	5 cm	Krom	300	18.40
---------------	-------	-------------	------	------	-----	-------



• Beyaz



• Krom

DUVAR GEÇİŞ KILIFI

Ürün Kodu	Kısa Kod	Ölçü	Yüzey	Yük	Fiyat
-----------	----------	------	-------	-----	-------

5201.00910.03.2	13542	1"	Gri	400	4.00
-----------------	-------	----	-----	-----	------



PANEL MONTAJ AYAĞI

Ürün Kodu	Kısa Kod	Ölçü	Yüzey	Yük	Fiyat
-----------	----------	------	-------	-----	-------

2700.300.00.B	13543	30 cm	Boyalı	50	56.00
2700.400.00.B	13544	40 cm	Boyalı	50	56.00
2700.500.00.B	13545	50 cm	Boyalı	40	56.00
2700.600.00.B	13546	60 cm	Boyalı	50	56.00
2700.900.00.B	13547	90 cm	Boyalı	50	56.00



PASLANMAZ BORDÜR

Ürün Kodu	Kısa Kod	Kalınlık	Boy		Fiyat	10 MM
-----------	----------	----------	-----	---	-------	-------

SS 304

PB.01.304P:10	13590	0.50 mm	244 cm	100	26.70
---------------	-------	---------	--------	-----	-------

SS 201

PB.19.201P:10	13591	0.50 mm	244 cm	100	23.40
---------------	-------	---------	--------	-----	-------

SS 430

PB.37.430P:10	13594	0.50 mm	244 cm	100	20.00
---------------	-------	---------	--------	-----	-------



PASLANMAZ BORDÜR

Ürün Kodu	Kısa Kod	Kalınlık	Boy		Fiyat	15 MM
-----------	----------	----------	-----	---	-------	-------

SS 304

PB.02.304P:15	13595	0.50 mm	244 cm	100	30.00
---------------	-------	---------	--------	-----	-------

SS 201

PB.20.201P:15	13596	0.50 mm	244 cm	100	26.70
---------------	-------	---------	--------	-----	-------

SS 430

PB.38.430P:15	13597	0.50 mm	244 cm	100	21.00
---------------	-------	---------	--------	-----	-------



PASLANMAZ BORDÜR

Ürün Kodu	Kısa Kod	Kalınlık	Boy		Fiyat	23 MM
-----------	----------	----------	-----	---	-------	-------

SS 304

PB.03.304P:23	13598	0.50 mm	244 cm	75	35.00
---------------	-------	---------	--------	----	-------

SS 201

PB.21.201P:23	13599	0.50 mm	244 cm	75	33.40
---------------	-------	---------	--------	----	-------

SS 430

PB.39.430P:23	13600	0.50 mm	244 cm	75	26.00
---------------	-------	---------	--------	----	-------



304 , 201 ve 430 kalite paslanmaz çelikten üretilmiştir. Zemin ve duvarda kullanıma uygundur. Seramiklere güzellik katan ve duvar ve zeminde genelde farklı renk ve farklı çeşit seramik geçişlerinde kullanılmaktadır. Üretici olmamızın bize verdiği avantaj ile sizlere sadece standart ölçülerde değil, projenize ve ürününüze uygun ürünlerde de üretim yapabilmekteyiz.

PASLANMAZ BORDÜR

Ürün Kodu	Kısa Kod	Kalınlık	Boy		Fiyat	30 MM
-----------	----------	----------	-----	---	-------	-------

SS 304

PB.04.304P30	13601	0.50 mm	244 cm	55	41.70
--------------	-------	---------	--------	----	-------

SS 201

PB.22.201P30	13602	0.50 mm	244 cm	55	38.40
--------------	-------	---------	--------	----	-------

SS 430

PB.40.430P30	13604	0.50 mm	244 cm	55	30.00
--------------	-------	---------	--------	----	-------



PASLANMAZ BORDÜR

Ürün Kodu	Kısa Kod	Kalınlık	Boy		Fiyat	40 MM
-----------	----------	----------	-----	---	-------	-------

SS 304

PB.05.304P40	13606	0.50 mm	244 cm	40	53.40
--------------	-------	---------	--------	----	-------

SS 201

PB.23.201P40	13605	0.50 mm	244 cm	40	48.40
--------------	-------	---------	--------	----	-------

SS 430

PB.41.430P40	13607	0.50 mm	244 cm	40	35.00
--------------	-------	---------	--------	----	-------



PASLANMAZ BORDÜR

Ürün Kodu	Kısa Kod	Kalınlık	Boy		Fiyat	50 MM
-----------	----------	----------	-----	---	-------	-------

SS 304

PB.06.304P50	13609	0.50 mm	244 cm	30	61.70
--------------	-------	---------	--------	----	-------

SS 201

PB.24.201P50	13608	0.50 mm	244 cm	30	56.00
--------------	-------	---------	--------	----	-------

SS 430

PB.42.430P50	13610	0.50 mm	244 cm	30	41.70
--------------	-------	---------	--------	----	-------



304 , 201 ve 430 kalite paslanmaz çelikten üretilmiştir. Zemin ve duvarda kullanıma uygundur. Seramiklere güzellik katan ve duvar ve zeminde genelde farklı renk ve farklı çeşit seramik geçişlerinde kullanılmaktadır. Üretici olmamızın bize verdiği avantaj ile sizlere sadece standart ölçülerde değil, projenize ve ürünüze uygun ürünlerde de üretim yapabilmekteyiz.

PASLANMAZ BORDÜR

Ürün Kodu	Kısa Kod	Kalınlık	Boy		Fiyat	10 MM
-----------	----------	----------	-----	---	-------	-------

SS 304

PB.07.304G.10	13612	0.50 mm	244 cm	100	45.00
---------------	-------	---------	--------	-----	-------

SS 201

PB.24.201G.10	13611	0.50 mm	244 cm	100	33.40
---------------	-------	---------	--------	-----	-------

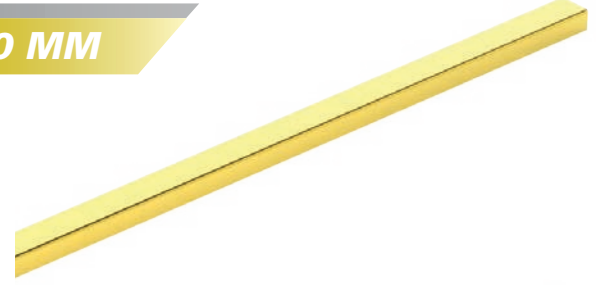

PASLANMAZ BORDÜR

Ürün Kodu	Kısa Kod	Kalınlık	Boy		Fiyat	15 MM
-----------	----------	----------	-----	---	-------	-------

SS 304

PB.08.304G.15	13615	0.50 mm	244 cm	100	53.40
---------------	-------	---------	--------	-----	-------

SS 201

PB.26.201G.15	13613	0.50 mm	244 cm	100	45.00
---------------	-------	---------	--------	-----	-------

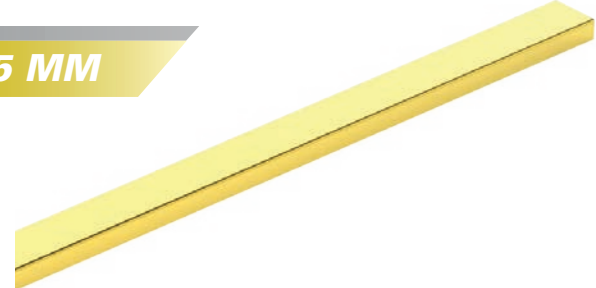

PASLANMAZ BORDÜR

Ürün Kodu	Kısa Kod	Kalınlık	Boy		Fiyat	23 MM
-----------	----------	----------	-----	---	-------	-------

SS 304

PB.09.304G.23	13617	0.50 mm	244 cm	75	66.70
---------------	-------	---------	--------	----	-------

SS 201

PB.27.201G.23	13616	0.50 mm	244 cm	75	50.00
---------------	-------	---------	--------	----	-------

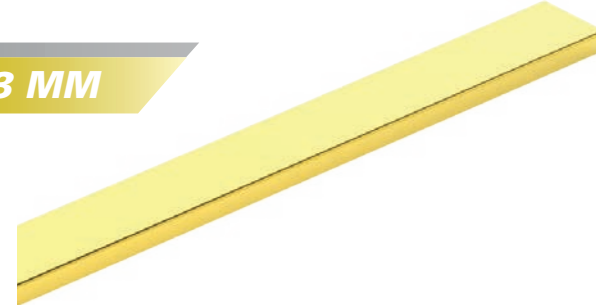

PASLANMAZ BORDÜR

Ürün Kodu	Kısa Kod	Kalınlık	Boy		Fiyat	30 MM
-----------	----------	----------	-----	---	-------	-------

SS 304

PB.10.304G.30	13619	0.50 mm	244 cm	55	76.70
---------------	-------	---------	--------	----	-------

SS 201

PB.28.201G.30	13618	0.50 mm	244 cm	55	58.30
---------------	-------	---------	--------	----	-------

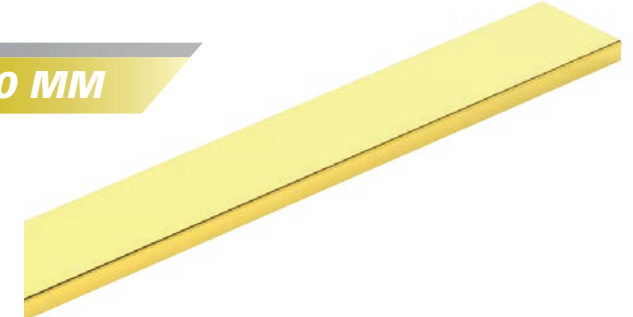

PASLANMAZ BORDÜR

Ürün Kodu	Kısa Kod	Kalınlık	Boy		Fiyat	40 MM
-----------	----------	----------	-----	---	-------	-------

SS 304

PB.11.304G.40	13621	0.50 mm	244 cm	40	95.00
---------------	-------	---------	--------	----	-------

SS 201

PB.29.201G.40	13620	0.50 mm	244 cm	40	70.00
---------------	-------	---------	--------	----	-------

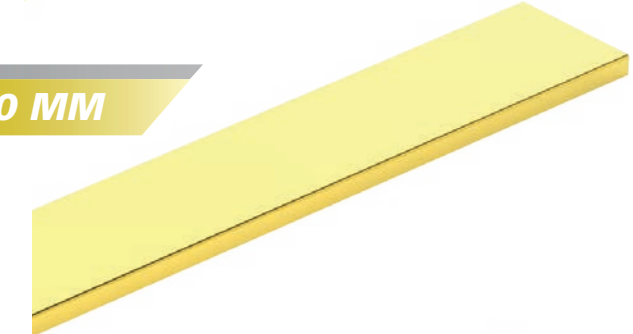

PASLANMAZ BORDÜR

Ürün Kodu	Kısa Kod	Kalınlık	Boy		Fiyat	50 MM
-----------	----------	----------	-----	---	-------	-------

SS 304

PB.12.304G.50	13623	0.50 mm	244 cm	30	111.70
---------------	-------	---------	--------	----	--------

SS 201

PB.30.201G.50	13622	0.50 mm	244 cm	30	82.40
---------------	-------	---------	--------	----	-------

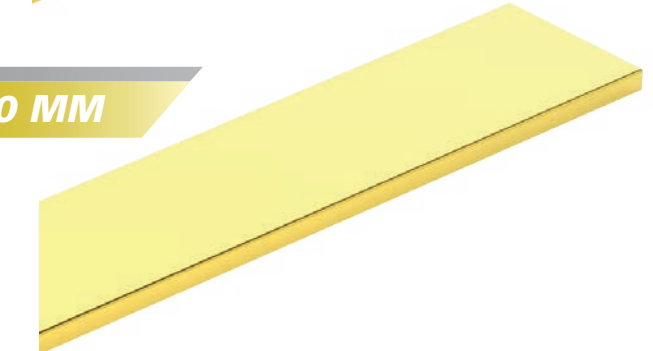

SERAMİK BORDÜRLER

MAXIFLOW

PASLANMAZ BORDÜR

Ürün Kodu Kısa Kod Kalınlık Boy Fiyat **10 MM**

SS 304

PB.13.304B.10 13625 0.50 mm 244 cm 100 51.70

SS 201

PB.31.201B.10 13624 0.50 mm 244 cm 100 36.70

PASLANMAZ BORDÜR

Ürün Kodu Kısa Kod Kalınlık Boy Fiyat **15 MM**

SS 304

PB.14.304B.15 13627 0.50 mm 244 cm 100 76.70

SS 201

PB.32.201B.15 13626 0.50 mm 244 cm 100 41.70

PASLANMAZ BORDÜR

Ürün Kodu Kısa Kod Kalınlık Boy Fiyat **23 MM**

SS 304

PB.15.304B.23 13629 0.50 mm 244 cm 75 78.40

SS 201

PB.33.201B.23 13628 0.50 mm 244 cm 75 51.70

PASLANMAZ BORDÜR

Ürün Kodu Kısa Kod Kalınlık Boy Fiyat **30 MM**

SS 304

PB.16.304B.30 13631 0.50 mm 244 cm 55 92.70

SS 201

PB.34.201B.30 13630 0.50 mm 244 cm 55 63.40

PASLANMAZ BORDÜR

Ürün Kodu Kısa Kod Kalınlık Boy Fiyat **40 MM**

SS 304

PB.17.304B.40 13633 0.50 mm 244 cm 40 113.40

SS 201

PB.35.201B.40 13632 0.50 mm 244 cm 40 76.70

PASLANMAZ BORDÜR

Ürün Kodu Kısa Kod Kalınlık Boy Fiyat **50 MM**

SS 304

PB.18.304B.50 13635 0.50 mm 244 cm 30 111.70

SS 201

PB.36.201B.50 13634 0.50 mm 244 cm 30 82.70

LİLA PASLANMAZ BORDÜR

Ürün Kodu	Kısa Kod	Kalınlık	Boy	Fiyat	30 MM
-----------	----------	----------	-----	-------	-------

SS 304

PB.46.304P30	13637	0.50 mm	244 cm	55	50.00
--------------	-------	---------	--------	----	-------

SS 201

PB.43.201P30	13636	0.50 mm	244 cm	55	44.00
--------------	-------	---------	--------	----	-------



LİLA PASLANMAZ BORDÜR

Ürün Kodu	Kısa Kod	Kalınlık	Boy	Fiyat	30 MM
-----------	----------	----------	-----	-------	-------

SS 304

PB.47.304G.30	13639	0.50 mm	244 cm	55	76.00
---------------	-------	---------	--------	----	-------

SS 201

PB.44.201G.30	13638	0.50 mm	244 cm	55	56.00
---------------	-------	---------	--------	----	-------



LİLA PASLANMAZ BORDÜR

Ürün Kodu	Kısa Kod	Kalınlık	Boy	Fiyat	30 MM
-----------	----------	----------	-----	-------	-------

SS 304

PB.48.304B.30	13641	0.50 mm	244 cm	55	100.00
---------------	-------	---------	--------	----	--------

SS 201

PB.45.201B.30	13640	0.50 mm	244 cm	55	61.70
---------------	-------	---------	--------	----	-------

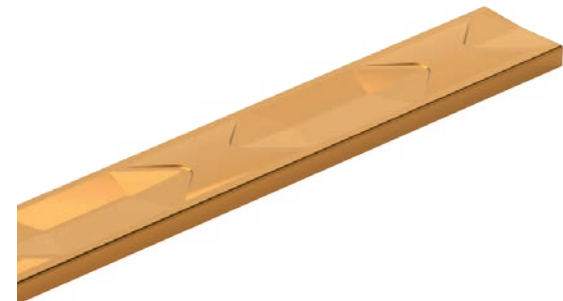

304 , 201 ve 430 kalite paslanmaz çelikten üretilmiştir. Zemin ve duvarda kullanıma uygundur. Seramiklere güzellik katan ve duvar ve zeminde genelde farklı renk ve farklı çeşit seramik geçişlerinde kullanılmaktadır. Üretici olmamızın bize verdiği avantaj ile sizlere sadece standart ölçülerde değil, projenize ve ürününüze uygun ürünlerde de üretim yapabilmekteyiz.

AÇIK KARE

Ürün Kodu	Kısa Kod	Kalınlık	Boy		Fiyat	10 MM
-----------	----------	----------	-----	---	-------	-------

SS 304

PB.81.304P10	13643	0.50 mm	244 cm	60	59.30
--------------	-------	---------	--------	----	-------

SS 201

PB.80.201P10	13642	0.50 mm	244 cm	60	54.00
--------------	-------	---------	--------	----	-------



DİK KENAR BİTİM BORDÜR

Ürün Kodu	Kısa Kod	Kalınlık	Boy		Fiyat	10 MM
-----------	----------	----------	-----	---	-------	-------

SS 304

PB.83.304P10	13645	0.50 mm	244 cm	60	59.30
--------------	-------	---------	--------	----	-------

SS 201

PB.82.201P10	13644	0.50 mm	244 cm	60	54.00
--------------	-------	---------	--------	----	-------

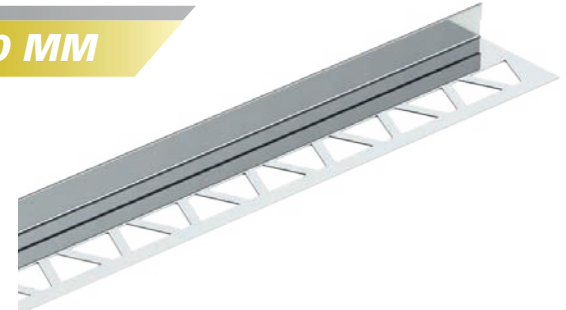

AÇIK OVAL BORDÜR

Ürün Kodu	Kısa Kod	Kalınlık	Boy		Fiyat	12 MM
-----------	----------	----------	-----	---	-------	-------

SS 304

PB.89.304P12	13647	0.50 mm	244 cm	60	59.40
--------------	-------	---------	--------	----	-------

SS 201

PB.88.201P12	13646	0.50 mm	244 cm	60	54.00
--------------	-------	---------	--------	----	-------

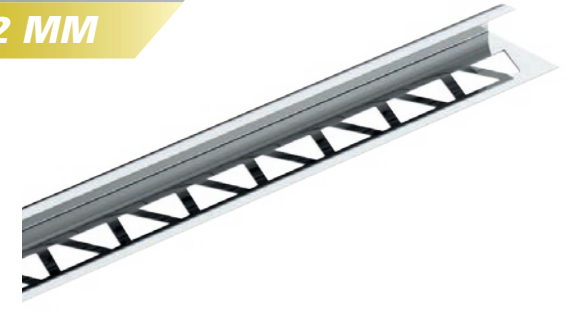

İÇ KÖŞE BORDÜR

Ürün Kodu	Kısa Kod	Kalınlık	Boy		Fiyat	10 MM
-----------	----------	----------	-----	---	-------	-------

SS 304

PB.85.304P10	13649	0.50 mm	244 cm	60	59.40
--------------	-------	---------	--------	----	-------

SS 201

PB.84.201P10	13648	0.50 mm	244 cm	60	54.00
--------------	-------	---------	--------	----	-------

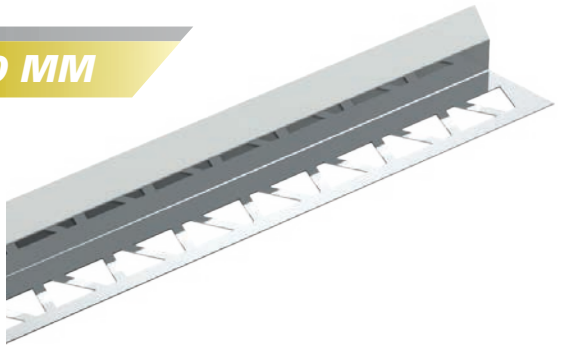

ÇİFT KÖŞE BORDÜR

Ürün Kodu	Kısa Kod	Kalınlık	Boy		Fiyat	10 MM
-----------	----------	----------	-----	---	-------	-------

SS 304

PB.87.304P10	13651	0.50 mm	244 cm	30	110.70
--------------	-------	---------	--------	----	--------

SS 201

PB.86.201P10	13650	0.50 mm	244 cm	30	98.70
--------------	-------	---------	--------	----	-------

